

UNIMIG

RazorWeld

TIG STICK 200 AC/DC



OPERATING MANUAL

KUM-M-RTIG200ACDC



Please read and understand this instruction manual carefully before the installation and operation of this equipment.

© Welding Guns Of Australia PTY LTD 2019

Thank you for your purchase of your RAZOR TIG 200 AC/DC Welding Machine.

We are proud of our range of plasma cutting and welding equipment that has a proven track record of innovation, performance and reliability.

Our product range represents the latest developments in Inverter technology put together by our professional team of highly skilled engineers. The expertise gained from our long involvement with inverter technology has proven to be invaluable towards the evolution and future development of our equipment range. This experience gives us the inside knowledge on what the arc characteristics, performance and interface between man and machine should be.

Within our team are specialist welders that have a proven history of welding knowledge and expertise, giving vital input towards ensuring that our machines deliver control and performance to the utmost professional level.

We employ an expert team of professional sales, marketing and technical personnel that provide us with market trends, market feedback and customer comments and requirements. Secondly they provide a customer support service that is second to none, thus ensuring our customers have confidence that they will be well satisfied both now and in the future.

UNIMIG welders and plasma cutters are manufactured to be compliant with - AS/NZ 60974-1, guaranteeing you electrical safety and performance.

WARRANTY

- 3 Years from date of purchase.
- Welding Guns Of Australia PTY LTD Ltd warranties all goods as specified by the manufacturer of those goods.
- This Warranty does not cover freight or goods that have been interfered with.
- All goods in question must be repaired by an authorised repair agent as appointed by this company.
- Warranty does not cover abuse, misuse, accident, theft, general wear and tear.
- New product will not be supplied unless Welding Guns Of Australia PTY LTD has inspected product returned for warranty and agrees to replace product.
- Product will only be replaced if repair is not possible
- Please view full Warranty term and conditions supplied with machine or at www.unimig.com.au/warranty-registration/ or at the back of this manual.

**REGISTER YOUR MACHINE ONLINE TO RECEIVE AN
ADDITIONAL 6 MONTHS ON YOUR WARRANTY**

Visit unimig.com.au/warranty-registration/ to register your machine.

WARRANTY.....	2
SAFETY.....	4
RAZOR TIG 200 AC/DC FEATURES.....	8
RAZOR TIG 200 AC/DC TECHNICAL DATA.....	9
MACHINE PARTS LAYOUT.....	10
FRONT PANEL OPERATION.....	11
WELD PROGRAM OPERATION.....	12
ADDITIONAL FRONT PANEL OPERATION.....	13
H/F DC TIG SETUP.....	14
DC TIG WELDING GUIDE.....	15
DC PULSE TIG SETUP.....	17
MANUAL TIG WELDING TECHNIQUE.....	18
H/F AC TIG SETUP.....	19
AC SQUARE WAVE FREQUENCY CONTROL.....	20
AC TIG WELDING GUIDE.....	21
AC PULSE TIG SETUP.....	23
TUNGSTEN ELECTRODES.....	25
MMA (STICK) WELDING SET UP.....	28
MMA (STICK) WELDING GUIDE.....	29
T2 TIG TORCH & SPARES.....	31
T2 TIG TORCH TUNGSTEN ELECTRODES.....	33
TIG WELDING TROUBLE SHOOTING.....	34
MMA (STICK) WELDING TROUBLE SHOOTING.....	35
WARRANTY TERMS.....	36
NOTES.....	39

Welding and cutting equipment can be dangerous to both the operator and people in or near the surrounding working area, if the equipment is not correctly operated. Equipment must only be used under the strict and comprehensive observance of all relevant safety regulations.

Read and understand this instruction manual carefully before the installation and operation of this equipment.

Machine Operating Safety

- Do not switch the function modes while the machine is operating. Switching of the function modes during welding can damage the machine. Damage caused in this manner will not be covered under warranty.
- Disconnect the electrode-holder cable from the machine before switching on the machine, to avoid arcing should the electrode be in contact with the work piece.
- Operators should be trained and or qualified.



Electric shock: It can kill. Touching live electrical parts can cause fatal shocks or severe burns. The electrode and work circuit is electrically live whenever the output is on. The input power circuit and internal machine circuits are also live when power is on. In MIG/MAG welding, the wire, drive rollers, wire feed housing, and all metal parts touching the welding wire are electrically live. Incorrectly installed or improperly grounded equipment is dangerous.

- Connect the primary input cable according to Australian and New Zealand standards and regulations.
- Avoid all contact with live electrical parts of the welding/cutting circuit, electrodes and wires with bare hands.
- The operator must wear dry welding gloves while he/she performs the welding/cutting task.
- The operator should keep the work piece insulated from himself/herself.
- Keep cords dry, free of oil and grease, and protected from hot metal and sparks.
- Frequently inspect input power cable for wear and tear, replace the cable immediately if damaged, bare wiring is dangerous and can kill.
- Do not use damaged, under sized, or badly joined cables.
- Do not drape cables over your body.
- We recommend (RCD) safety switch is used with this equipment to detect any leakage of current to earth.



Fumes and gases are dangerous. Smoke and gas generated whilst welding or cutting can be harmful to people's health. Welding produces fumes and gases. Breathing these fumes and gases can be hazardous to your health.

Do not breathe the smoke and gas generated whilst welding or cutting, keep your head out of the fumes

- Keep the working area well ventilated, use fume extraction or ventilation to remove welding/cutting fumes and gases.
- In confined or heavy fume environments always wear an approved air-supplied respirator.
- Welding/cutting fumes and gases can displace air and lower the oxygen level causing injury or death. Be sure the breathing air is safe.
- Do not weld/cut in locations near de-greasing, cleaning, or spraying operations. The heat and rays of the arc can react with vapours to form highly toxic and irritating gases.
- Materials such as galvanized, lead, or cadmium plated steel, containing elements that can give off toxic fumes when welded/cut. Do not weld/cut these materials unless the area is very well ventilated, and or wearing an air supplied respirator.



Arc rays: harmful to people's eyes and skin. Arc rays from the welding/cutting process produce intense visible and invisible ultraviolet and infrared rays that can burn eyes and skin.

Always wear a welding helmet with correct shade of filter lens and suitable protective clothing including welding gloves whilst the welding/cutting operation is performed.

- Measures should be taken to protect people in or near the surrounding working area. Use protective screens or barriers to protect others from flash, glare and sparks; warn others not to watch the arc.



Fire hazard. Welding/cutting on closed containers, such as tanks, drums, or pipes, can cause them to explode. Flying sparks from the welding/cutting arc, hot work piece, and hot equipment can cause fires and burns. Accidental contact of electrode to metal objects can cause sparks, explosion, overheating, or fire. Check and be sure the area is safe before doing any welding/cutting.

- The welding/cutting sparks & spatter may cause fire, therefore remove any flammable materials well away from the working area. Cover flammable materials and containers with approved covers if unable to be moved from the welding/cutting area.
- Do not weld/cut on closed containers such as tanks, drums, or pipes, unless they are properly prepared according to the required Safety Standards to insure that flammable or toxic vapours and substances are totally removed, these can cause an explosion even though the vessel has been "cleaned". Vent hollow castings or containers before heating, cutting or welding. They may explode.
- Do not weld/cut where the atmosphere may contain flammable dust, gas, or liquid vapours (such as petrol)
- Have a fire extinguisher nearby and know how to use it. Be alert that welding/cutting sparks and hot materials from welding/cutting can easily go through small cracks and openings to adjacent areas. Be aware that welding/cutting on a ceiling, floor, bulkhead, or partition can cause fire on the hidden side.



Gas Cylinders. Shielding gas cylinders contain gas under high pressure. If damaged, a cylinder can explode. Because gas cylinders are normally part of the welding/cutting process, be sure to treat them carefully. CYLINDERS can explode if damaged.

- Protect gas cylinders from excessive heat, mechanical shocks, physical damage, slag, open flames, sparks, and arcs.
- Insure cylinders are held secure and upright to prevent tipping or falling over.
- Never allow the welding/cutting electrode or earth clamp to touch the gas cylinder, do not drape welding cables over the cylinder.
- Never weld/cut on a pressurised gas cylinder, it will explode and kill you.
- Open the cylinder valve slowly and turn your face away from the cylinder outlet valve and gas regulator.



Gas build up. The build up of gas can causes a toxic environment, deplete the oxygen content in the air resulting in death or injury. Many gases use in welding/cutting are invisible and odourless.

- Shut off shielding gas supply when not in use.
- Always ventilate confined spaces or use approved air-supplied respirator.



Electronic magnetic fields. MAGNETIC FIELDS can affect Implanted Medical Devices.

- Wearers of Pacemakers and other Implanted Medical Devices should keep away.
- Implanted Medical Device wearers should consult their doctor and the device manufacturer before going near any electric welding, cutting or heating operation.



Noise can damage hearing. Noise from some processes or equipment can damage hearing.

- Wear approved ear protection if noise level is high.



Hot parts. Items being welded/cut generate and hold high heat and can cause severe burns.

Do not touch hot parts with bare hands. Allow a cooling period before working on the welding/cutting gun. Use insulated welding gloves and clothing to handle hot parts and prevent burns.

CAUTION

1. Working Environment.

- i. The environment in which this welding/cutting equipment is installed must be free of grinding dust, corrosive chemicals, flammable gas or materials etc, and at no more than maximum of 80% humidity.
- ii. When using the machine outdoors protect the machine from direct sun light, rain water and snow etc; the temperature of working environment should be maintained within -10°C to +40°C.
- iii. Keep this equipment 30cm distant from the wall.
- iv. Ensure the working environment is well ventilated.

2. Safety Tips.

i. Ventilation

This equipment is small-sized, compact in structure, and of excellent performance in amperage output. The fan is used to dissipate heat generated by this equipment during the welding/cutting operation. Important: Maintain good ventilation of the louvers of this equipment. The minimum distance between this equipment and any other objects in or near the working area should be 30 cm. Good ventilation is of critical importance for the normal performance and service life of this equipment.

ii. Thermal Overload protection.

Should the machine be used to an excessive level, or in high temperature environment, poorly ventilated area or if the fan malfunctions the Thermal Overload Switch will be activated and the machine will cease to operate. Under this circumstance, leave the machine switched on to keep the built-in fan working to bring down the temperature inside the equipment. The machine will be ready for use again when the internal temperature reaches safe level.

iii. Over-Voltage Supply

Regarding the power supply voltage range of the machine, please refer to "Main parameter" table. This equipment is of automatic voltage compensation, which enables the maintaining of the voltage range within the given range. In case that the voltage of input power supply amperage exceeds the stipulated value, it is possible to cause damage to the components of this equipment. Please ensure your primary power supply is correct.

- iv. Do not come into contact with the output terminals while the machine is in operation. An electric shock may possibly occur.

MAINTENANCE

Exposure to extremely dusty, damp, or corrosive air is damaging to the welding/cutting machine. In order to prevent any possible failure or fault of this welding/cutting equipment, clean the dust at regular intervals with clean and dry compressed air of required pressure.

Please note that: lack of maintenance can result in the cancellation of the guarantee; the guarantee of this welding/cutting equipment will be void if the machine has been modified, attempt to take apart the machine or open the factory-made sealing of the machine without the consent of an authorized representative of the manufacturer.

TROUBLE SHOOTING

Caution: Only qualified technicians are authorized to undertake the repair of this welding/cutting equipment. For your safety and to avoid Electrical Shock, please observe all safety notes and precautions detailed in this manual.

ATTENTION! - CHECK FOR GAS LEAKAGE

At initial set up and at regular intervals we recommend to check for gas leakage

Recommended procedure is as follows:

1. Connect the regulator and gas hose assembly and tighten all connectors and clamps.
2. Slowly open the cylinder valve.
3. Set the flow rate on the regulator to approximately 8-10 L/min.
4. Close the cylinder valve and pay attention to the needle indicator of the contents pressure gauge on the regulator, if the needle drops away towards zero there is a gas leak. Sometimes a gas leak can be slow and to identify it will require leaving the gas pressure in the regulator and line for an extended time period. In this situation it is recommended to open the cylinder valve, set the flow rate to 8-10 L/min, close the cylinder valve and check after a minimum of 15 minutes.
5. If there is a gas loss then check all connectors and clamps for leakage by brushing or spraying with soapy water, bubbles will appear at the leakage point.
6. Tighten clamps or fittings to eliminate gas leakage.

IMPORTANT! - We strongly recommend that you check for gas leakage prior to operation of your machine. We recommend that you close the cylinder valve when the machine is not in use.

Welding Guns Of Australia PTY LTD, authorised representatives or agents of Welding Guns Of Australia PTY LTD will not be liable or responsible for the loss of any gas.



FEATURES

- 15 AMP Plug
- AC/DC H/F TIG & PULSE TIG
 - Pre Gas 0.1 - 3.0 sec
 - Start Amperage 10 - 200A
 - Up Slope 0 - 10 sec
 - Peak Amp 10 - 200A
 - AC Square Wave 20 - 250Hz
 - AC Balance Control ± 10
 - Down Slope 0 - 15 sec
 - Adjustable Finish Amperage 10 - 200A
 - Post Gas 0.5 - 15.0 sec
- STICK (MMA) with ARC FORCE
- Thermal overload protection
- IP21S rating for environmental/safety protection
- Generator compatible (recommend KVA minimum)
- VRD (Voltage Reduction Device)
- Foot Control Ready

OVERVIEW

The RAZOR TIG 200 AC/DC is the perfect AC/DC TIG & STICK Welder for professional welder wanting both AC and DC TIG welding capabilities. Fitted with a 15 AMP Plug, this machine is suited to light to medium industrial work.

The RAZOR TIG 200 AC/DC allows for full control over the TIG welding process to ensure you can maximise your results from start to finish. Controllable parameters include Pre Gas Time, Start Current, Up Slope and Down Slope Time, Finish Current Level and Post Gas Time, among many others.

The all-new ARC TORCHOLOGY T2 TIG Torch comes standard with the RAZOR TIG 200 AC/DC, offering up to 30% more power and longer consumable life-cycles. A Remote Foot Control (UTJRFC-4) can also be plugged into the machine for even more versatility.

With all of these features packed into an compact package, the RAZOR TIG 200 AC/DC is a must-have for any professional welder or TIG enthusiast.

MACHINE PACKAGE: KUM-M-RTIG200ACDC

- RAZOR TIG 200 AC/DC Power Source
- 4m High Performance T2 TIG Torch (including consumables)
- 4m Twist Lock Electrode Holder
- 300 Amp Earth Clamp & Lead
- Argon Flowmeter Regulator
- 2m Gas Hose Complete with fittings
- Operating Manual

TECHNICAL DATA	
MACHINE	RAZOR TIG 200 AC/DC
SKU	KUM-M-RTIG200ACDC
PRIMARY INPUT VOLTAGE	240V Single Phase
SUPPLY PLUG	15 AMP
RATED INPUT POWER (kVA)	6.0
I _{eff} (A)	15.0
I _{max} (A)	29.0
RATED OUTPUT	10-200A/18.0V
NO LOAD VOLTAGE (V)	9-68
PROTECTION CLASS	IP21S
INSULATION CLASS	F
POWER FACTOR	0.7
MINIMUM GENERATOR (kVA)	9.0
DINSE CONNECTOR	35/50
STANDARD	AS/NZ60974-1
WELDS	Mild Steel, Stainless Steel, Cast Iron, Silicon Bronze, Copper, Aluminium, Zinc Alloys
WARRANTY (Years)	3

TIG SPECIFICATIONS	
TIG FUNCTION TYPE	AC/DC HF TIG & AC/DC Pulse
TIG WELDING CURRENT RANGE	10-200A
TIG DUTY CYCLE @ 40°C	25% @ 200A
TIG WELDING THICKNESS RANGE	1mm - 8mm

AC/DC TIG PARAMETERS	
PRE GAS	0.1-3.0s
START AMP	10-200A
UP SLOPE	0-10s
PEAK AMP	10-200A
AC SQUARE WAVE	20-250Hz
AC BALANCE CONTROL	±10
DOWN SLOPE	0-15s
FINISH AMP	10-200A
POST GAS	0.5-15.0s
PULSE FREQUENCY	0.2-200Hz
PULSE WIDTH	10-90%
SPOT	0.5-10s

STICK SPECIFICATIONS	
STICK WELDING CURRENT RANGE	10-160A
STICK DUTY CYCLE @ 40°C	30% @ 160A
STICK ELECTRODE RANGE	2.5-4.0mm
STICK WELDING THICKNESS RANGE	2mm - 12mm
ARC FORCE	0-40

SIZE & WEIGHT	
DIMENSIONS (mm)	426x162x326mm
WEIGHT (kg)	10kg

MACHINE FEATURES	
VRD	Yes
FOOT CONTROL READY	Yes (UTJCFC-4)
CRATER CURRENT CONTROL	Yes
THERMAL OVERLOAD PROTECTION	Yes



FRONT PANEL LAYOUT

1. Weld Function Selector
2. 2T / 4T / Spot Selector
3. Positive Output Terminal
4. Negative Output Terminal
5. Quick Lock Gas Connector
6. Torch Switch - Remote Connector
7. Encoder Knob
8. Weld Cycle Display



BACK PANEL LAYOUT

9. Power Switch
10. Mains Power Input Cable
11. Fan
12. Inlet Gas Connector

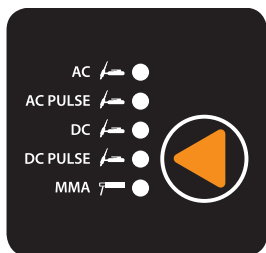

Mode Selector

Enables selection of required welding mode:

- AC TIG
- AC PULSE TIG
- DC TIG
- DC PULSE TIG
- DC MMA (Stick)

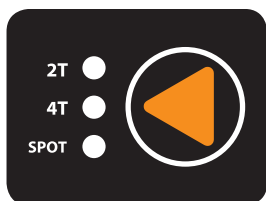

Torch Switch Mode Selector

Controls the on/off cycle of the machine using the torch switch while incorporating the weld program parameters selections:

- **2T** uses 2 actions of the torch switch while incorporating the weld program parameter selections.
- **4T** uses 4 actions of the torch switch while incorporating the weld program parameter selections. 4T provides operator control of the start and finish portions of the weld sequence.
- **Spot** uses a single action of the torch switch. Pressing the torch switch gives arc ignition and initialises the welding sequence for the period of time set using the spot timer.



Encoder Knob

Provides digital adjustment of welding parameters and provides step by step motion through the weld cycle parameters.

- **Turn the knob** to increase or decrease the desired value displayed on the LED display.
- **Press the knob** to cycle between each step of the weld cycle.

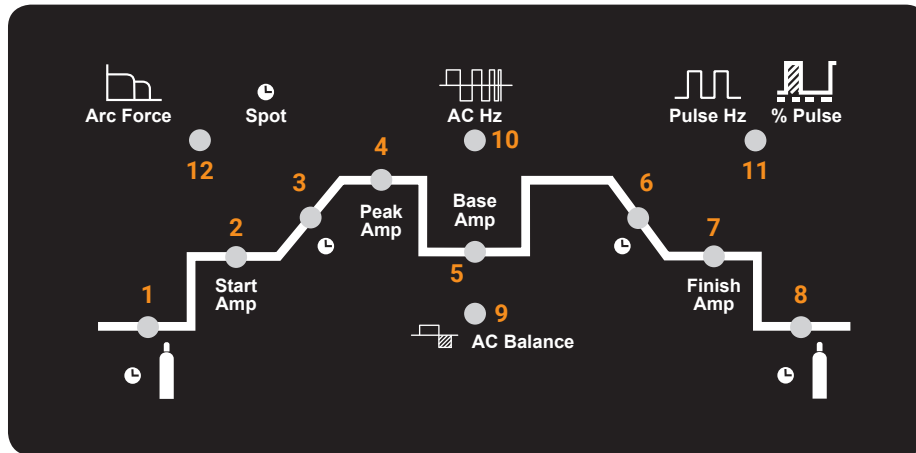

1. Pre Gas Timer

- Provides selection for gas flow time prior to the arc starting. **(0.1 - 3.0s)**

2. Start Amp

- Provides selection for the amount of amps required at the start of the weld. **(5 - 160 AMP)**

3. Up Slope Time

- Sets the transition time from Start Amperage to Welding Amperage. **(0-10s)**

4. Peak Amp

- Provides selection for the Maximum Welding Amperage required during welding. **(5 - 180 AMP)**

5. Base Amp

- Provides selection for the Base Amperage during the Pulse Welding cycle. **(5-180 AMP)**

6. Down Slope Time

- Sets the transition time from Welding Amperage to Finish Amperage. **(0 - 15s)**

7. Finish Amp

- Provides selection for the amount of amperage required at the end of the weld. **(5-180 AMP)**

8. Post Gas Timer

- Provides selection for continued gas flow time at the end of the welding after the arc is out. **(0.5-15s)**

9. AC Balance

- Provides selection to adjust the balance of the AC wave form in AC TIG mode. Allows adjustment of the arc to be balanced, penetrating or oxide cleaning during AC TIG welding. **(-5 to +5)**

10.AC Hz

- Provides selection to adjust the frequency of the AC square wave in AC TIG mode. Allows adjustment of frequency of the AC square wave cycle (transition from + to -) during AC TIG welding. **(20-250 Hz)**

11.Pulse Hz / % Pulse

- The **Pulse Hz / % Pulse** combines two functions under the same section. Upon first illuminating, the display will refer to the **Pulse Hz** value. **Push the Encoder Knob** once more to display the **% Pulse** value.

PULSE HZ

- Provides selection of the pulse frequency of the welding output current. Allows adjustment of frequency that the output current transitions from Peak Amp to Base Amp. **(0.02-200 Hz)**

% PULSE

- Provides selection of the on time ratio of the Peak Amp during the pulse welding cycle (Pulse Width). Allows adjustment of the % of time that the Peak Amp is on during each pulse cycle. **(10-90%)**

12.Spot / Arc Force

- The **Spot / Arc Force** combines two functions under the same section. When in **TIG** Mode, and **SPOT** is selected from the Torch Switch Mode Selector, the section will refer to **Spot**. When in **MMA** Mode, the section will refer to **Arc Force**.

SPOT

- Provides selection of a pre-set time period for welding current output. Allows adjustment of the time that machine will deliver amperage output from trigger activation. **(0.5-10s)**

ARC FORCE

- Provides selection for adjustment of the ARC FORCE during MMA (Stick) welding. Low value allows a soft arc, a higher value allows stronger digging arc. **(0-40)**

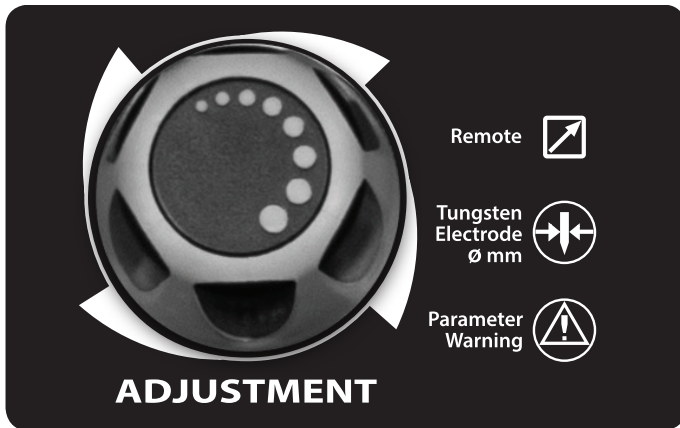

Remote

The remote icon illuminates when the remote function is active.

- **Remote Hand Control:** Press the torch switch and hold for 5 seconds the icon will illuminate when remote function is activated.
- **Remote Foot Control:** Remote function will become active when the foot control is connected.

Tungsten electrode Ømm

- For selection of Tungsten electrode and MMA electrode diameter. **(Value is mm)**

Parameter Warning

The warning parameter icon illuminates when the the weld parameter settings do not match the electrode size selection.

The machine will still function but it is a warning to the operator that the weld parameters chosen are outside the generally accepted capabilities of the electrode size selected. For example excessive amperage selected may overheat and destroy the tungsten electrode.

DC TIG PARAMETERS SELECTION:

- i. Select DC TIG
- ii. Set Tungsten Diameter
- iii. Set Pre-Gas Time
- iv. Set Start Amps
- v. Set Up Slope Time
- vi. Set Peak Amp
- vii. Set Down Slope
- viii. Set Finish Amp
- ix. Set Post Gas



1. Connect the TIG Torch connector to the negative terminal and tighten it.
2. Insert the torch gas connector into the quick lock gas receptacle.
3. Connect the torch switch remote lead into the torch remote socket.
4. Connect the Earth Cable connector into the positive terminal and tighten it.
5. Connect gas line to Gas Regulator and connect the gas regulator to the Gas Cylinder. Slowly open the valve on the gas cylinder and set gas flow to the required rate.
6. Connect the gas line to the quick lock gas inlet connector at the rear of the machine. Check for gas leaks - Welding Guns of Australia PTY LTD nor it's representatives will be responsible for any gas loss.
7. Switch on the machine using the On/Off switch at the rear of the machine.
8. Set the weld parameters using the front panel

Weld start procedure for HF DC TIG welding



(1) Lay the outside edge of the Gas Cup on the work piece with the Tungsten Electrode 1- 3mm from the work piece.



(2) Press the torch switch and the arc will ignite across the gap between the tungsten and work piece. Hold even distance of about 2mm gap between the tungsten and work piece to maintain the arc.



(3) Release the torch switch to bring in the end of the welding sequence dependant of 2T or 4T trigger function choice

DC TIG WELDING

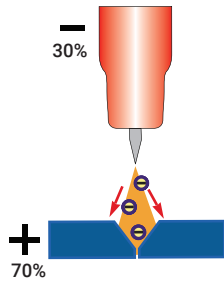

The DC power source uses what is known as DC (direct current) in which the main electrical component known as electrons flow in only one direction from the negative pole (terminal) to the positive pole (terminal). In the DC electrical circuit there is an electrical principle at work which should always be taken into account when using any DC circuit. With a DC circuit 70% of the energy (heat) is always on the positive side. This needs to be understood because it determines what terminal the TIG torch will be connected to (this rule applies to all the other forms of DC welding as well).

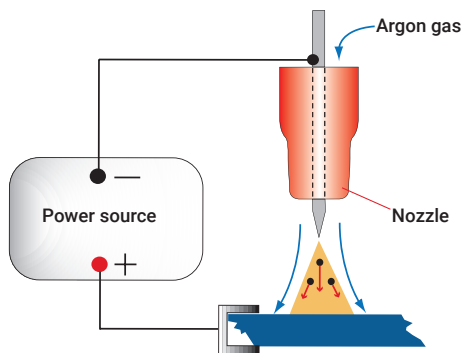

DC TIG welding is a process in which an arc is struck between a TUNGSTEN electrode and the metal work piece. The weld area is shielded by an inert gas flow to prevent contamination of the tungsten, molten pool and weld area. When the TIG arc is struck the inert gas is ionized and superheated changing its molecular structure which converts it into a plasma stream. This plasma stream flowing between the tungsten and the work piece is the TIG arc and can be as hot as 19,000°C. It is a very pure and concentrated arc which provides the controlled melting of most metals into a weld pool. TIG welding offers the user the greatest amount of flexibility to weld the widest range of material and thickness and types. DC TIG welding is also the cleanest weld with no sparks or spatter.

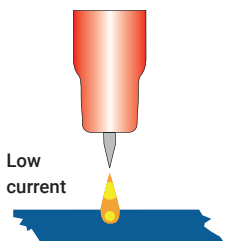

The intensity of the arc is proportional to the current that flows from the tungsten. The welder regulates the welding current to adjust the power of the arc. Typically thin material requires a less powerful arc with less heat to melt the material so less current (amps) is required, thicker material requires a more powerful arc with more heat so more current (amps) are necessary to melt the material.

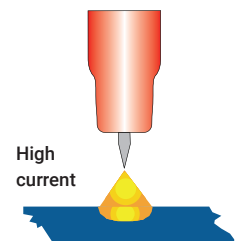

HF ARC IGNITION FOR TIG (TUNGSTEN INERT GAS) WELDING

HF (high frequency) ignition allows the arc to be started in Tig welding without touching the tungsten to the work piece. By pressing the torch switch the machine will activate the gas flow and introduce the HF (high frequency) (high voltage) spark, this "ionizes" the air gap making it conductive allowing an arc to be created without touching the tungsten to the work piece. The gas molecules are superheated by the arc creating a stream of super heated gas that changes the molecular structure into producing a plasma stream. This plasma stream provides heat and energy that allows us to melt and fuse metals in an inert gas shielded environment know as TIG (tungsten inert gas) welding.

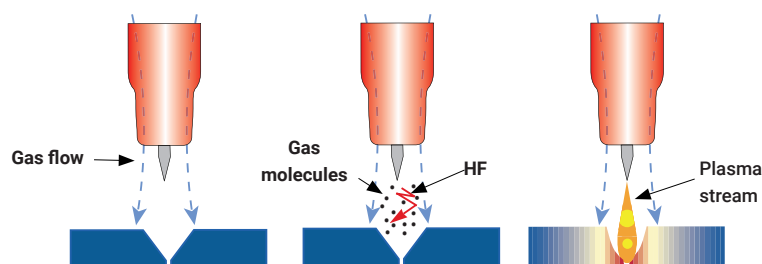

DC PULSE TIG WELDING GENERAL DESCRIPTION

Pulse TIG welding is when the current output (amperage) changes between high and low current.

Electronics within the welding machine create the pulse cycle. Welding is done during the high-amperage interval (this high amperage is referred to as peak current). During the low amperage period, the arc is maintained but the current output of the arc is reduced (this low amperage is referred to as base current). During pulse welding the weld pool cools during the low amperage period. This allows a lower overall heat input into the base metal. It allows for controlled heating and cooling periods during welding providing better control of heat input, weld penetration, operator control and weld appearance. There are 4 variables within the pulse cycle: Peak Current - Base Current - Pulse Frequency - Pulse Width

Setting and manipulation of these variables will determine the nature of the weld current output and is at the discretion of the operator.

Peak Current is the main welding current (amps) set to melt the material being welded and works much the same as setting maximum amperage values for regular DC TIG: as a guide use 30-40 amps for every 1mm of material thickness.

Base Current is the set level of background current (amps) which cools the weld puddle and affects overall heat input. Background Amps is a percentage of peak amperage. As a rule, use enough background current to reduce the weld pool to about half its normal size while still keeping the weld pool fluid. As a guide start by setting the background amperage at 20 to 30 percent of peak amperage.

Pulse Frequency is the control of the amount of times per second (Hz) that the welding current switches from Peak Current to Base Current. DC Pulse TIG frequency generally ranges from 20 to 300 HZ depending on the job application. Control of the pulse frequency also determines the appearance of the weld.

Pulse Width is the control of the percentage of time during one pulsing cycle the power source spends at the peak current (main amperage). Example is with the Pulse Width set at 80 percent and a rate of 1 pulse per second (PPS), the machine will spend 80% of the pulse at peak amperage and 20% at the base current. Increasing the pulse width percentage adds more heat to the job, while decreasing pulse width percentage reduces heat

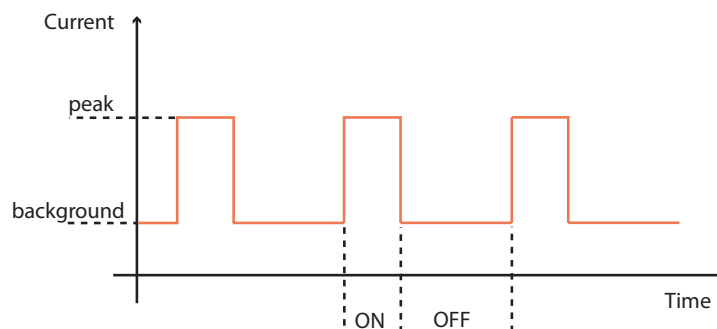

DC Pulse TIG welding allows faster welding speeds with better control of the heat input to the job, reducing the heat input minimising distortion and warping of the work and is of particular advantage in the welding of thin stainless steel and carbon steel applications. The high pulse frequency capability of the advanced inverter agitates the weld puddle and allows you to move quickly without transferring too much heat to the surrounding metal. Pulsing also constricts and focuses the arc thus increasing arc stability, penetration and travel speeds.

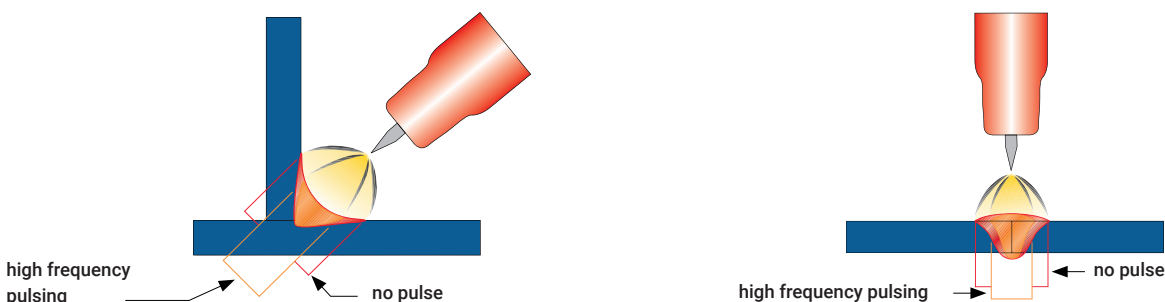

DC PULSE TIG WELDING SET UP PROCEDURE

This machine has digital pulse frequency control. All the parameters for DC Pulse Tig welding - Peak Amp, Base Amp, Pulse Frequency and Pulse Width are easy to set via the digital control panel.

EXAMPLE OF PULSE DC TIG WELDING - SETUP PARAMETERS:

Material = Stainless Steel x 2.0mm / Tungsten Electrode = 1.6mm 2% Thoriated / Gas = Argon

The following steps are a guide as a starting point for you to set the machine up in Pulse mode to give an example of welding in Pulse mode function. You can experiment by changing any of the variables to see what effect it has over the welding and what the end result can be, but it is suggested to change only one variable at a time and then check the welding to see what the result is, in this way you acquire a better understanding of how each variable affects the welding current.

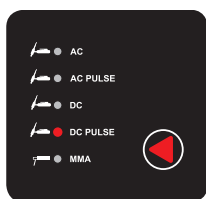

1. Select DC Pulse by pushing selector button to cycle through to illuminate DC Pulse icon.

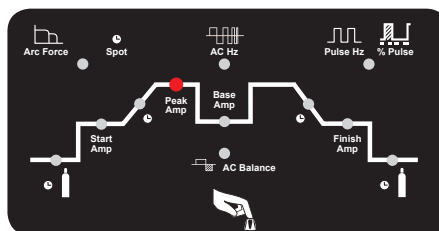

2. Select Peak Amp by pressing the encoder knob to cycle through to illuminate the Peak Amp icon.



3. Rotate the Encoder Knob to set the Peak Amp at 100A, it will show in the digital display. **(Range is 5-180 Amps)**

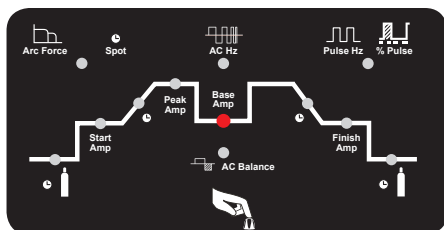

4. Select the Base Amp by pushing the encoder knob to cycle through to illuminate the Base Amp icon.



5. Rotate the Encoder Knob to set the Base Amp at 30A - **(Range is 5-180 Amps)**

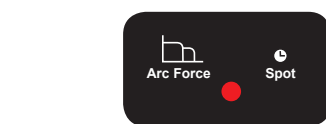
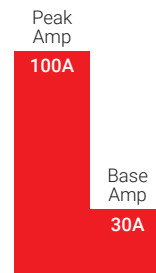

6. Select the Pulse Frequency by pushing the encoder knob to cycle through to illuminate the Pulse Hz icon.

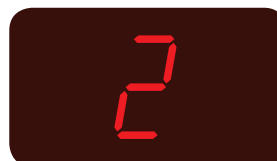

7. Rotate the Adjustment Encoder Knob to set the Pulse Frequency to 2 Hz - **(0.5 - 200Hz)**

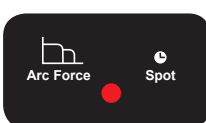
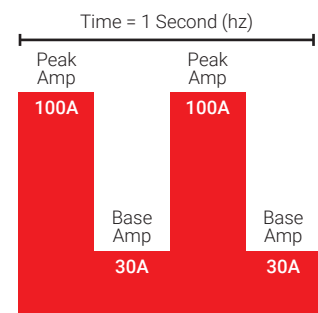

8. Select the Pulse Width (on time of the Peak Amp) by pushing the selector button to cycle through to illuminate the % Pulse icon.



9. Rotate the Adjustment Encoder Knob to set the Pulse Width at 60% - **(Range is 10 - 90%)**

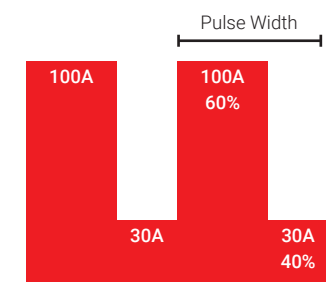

TIG WELDING FUSION TECHNIQUE

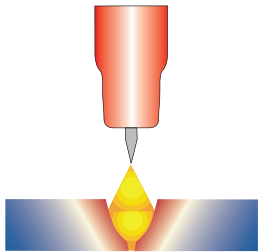

Manual TIG welding is often considered the most difficult of all the welding processes. Because the welder must maintain a short arc length, great care and skill are required to prevent contact between the electrode and the workpiece. Similar to Oxygen Acetylene torch welding, Tig welding normally requires two hands and in most instances requires the welder to manually feed a filler wire into the weld pool with one hand while manipulating the welding torch in the other. However, some welds combining thin materials can be accomplished without filler metal like edge, corner, and butt joints. This is known as Fusion welding where the edges of the metal pieces are melted together using only the heat and arc force generated by the TIG arc. Once the arc is started the torch tungsten is held in place until a weld pool is created, a circular movement of the tungsten will assist in creating a weld pool of the desired size. Once the weld pool is established tilt the torch at about a 75° angle and move smoothly and evenly along the joint while fusing the materials together.

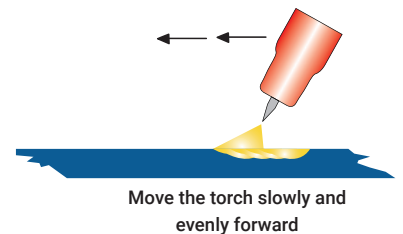
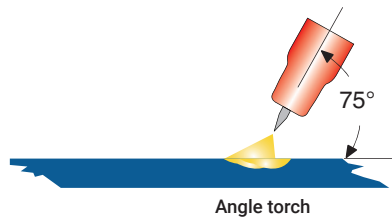
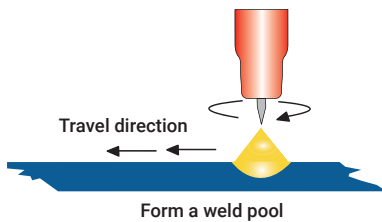

TIG WELDING WITH FILLER WIRE TECHNIQUE

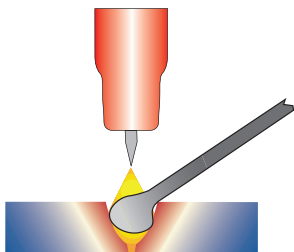

It is necessary in many situations with TIG welding to add a filler wire into the weld pool to build up weld reinforcement and create a strong weld. Once the arc is started the torch tungsten is held in place until a weld pool is created, a circular movement of the tungsten will assist in creating a weld pool of the desired size. Once the weld pool is established tilt the torch at about a 75° angle and move smoothly and evenly along the joint. The filler metal is introduced to the leading edge of the weld pool. The filler wire is usually held at about a 15° angle and fed into the leading edge of the molten pool, the arc will melt the filler wire into the weld pool as the torch is moved forward. Also a dabbing technique can be used to control the amount of filler wire added, the wire is fed into the molten pool and retracted in a repeating sequence as the torch is moved slowly and evenly forward. It is important during the welding to keep the molten end of the filler wire inside the gas shield as this protects the end of the wire from being oxidised and contaminating the weld pool.

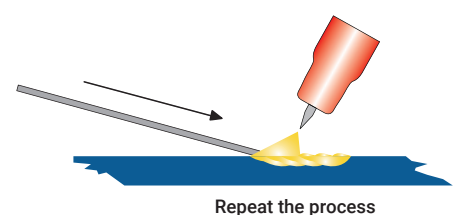
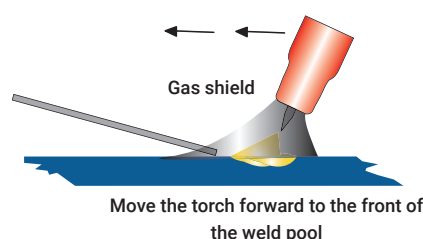
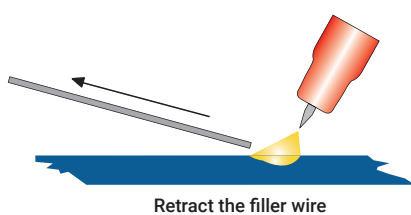
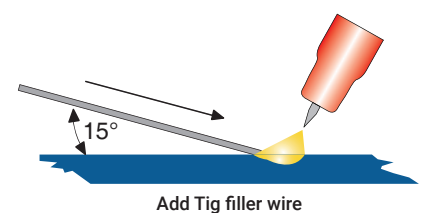
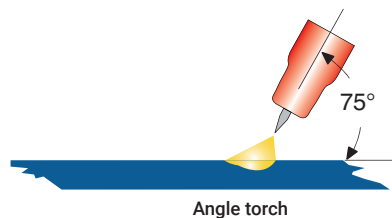
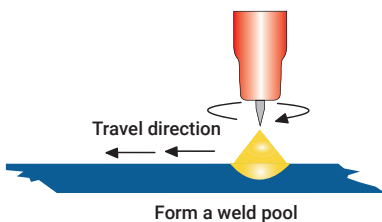

AC TIG PARAMETERS SELECTION:

- i. Select AC TIG
- ii. Set Tungsten Diameter
- iii. Set Pre-Gas Time
- iv. Set Start Amps
- v. Set Up Slope Time
- vi. Set Peak Amp
- vii. Set AC Square Wave Frequency
- viii. Set AC Balance
- ix. Set Down Slope
- x. Set Finish Amp
- xi. Set Post Gas



1. Connect the TIG Torch connector to the negative terminal and tighten it.
2. Insert the torch gas connector into the quick lock gas receptacle.
3. Connect the torch switch remote lead into the torch remote socket.
4. Connect the Earth Cable connector into the positive terminal and tighten it.
5. Connect gas line to Gas Regulator and connect the gas regulator to the Gas Cylinder. Slowly open the valve on the gas cylinder and set gas flow to the required rate.
6. Connect the gas line to the quick lock gas inlet connector at the rear of the machine. Check for gas leaks - Welding Guns of Australia PTY LTD nor it's representatives will be responsible for any gas loss.
7. Switch on the machine using the On/Off switch at the rear of the machine.
8. Set the weld parameters using the front panel

Weld start procedure for HF DC TIG welding



(1) Lay the outside edge of the Gas Cup on the work piece with the Tungsten Electrode 1- 3mm from the work piece.



(2) Press the torch switch and the arc will ignite across the gap between the tungsten and work piece. Hold even distance of about 2mm gap between the tungsten and work piece to maintain the arc.



(3) Release the torch switch to bring in the end of the welding sequence dependant of 2T or 4T trigger function choice.

AC SQUARE WAVE FREQUENCY CONTROL

It is possible with this machine to adjust the frequency of the AC Square Wave output. It means that the amount of time that it takes the AC square wave to complete a full cycle switch from positive (+) to negative (-) can be adjusted from 20Hz (20 times per second) to 200Hz

Increasing frequency (Hz) causes the current to change direction more often, which means that it spends less time per cycle in both DC electrode negative and DC electrode positive mode. By spending less time at each polarity, the arc cone has less time to expand.

A higher frequency produces a narrower arc cone producing an arc that is tighter with more focus at the exact spot the electrode is pointing. The result is improved arc stability, ideal for fillet welds and other fit ups requiring precise penetration. Decreasing the frequency softens the arc and broadens the weld pool producing a wider bead, produces good overall penetration and ideal for build up applications.

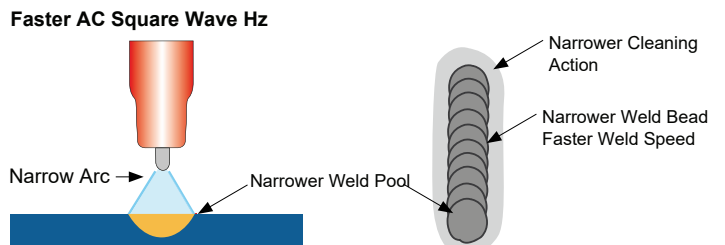
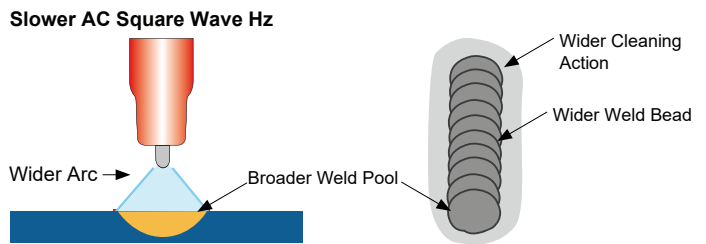
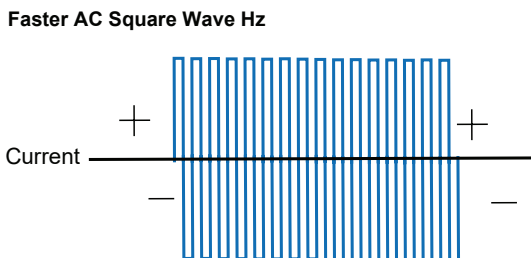
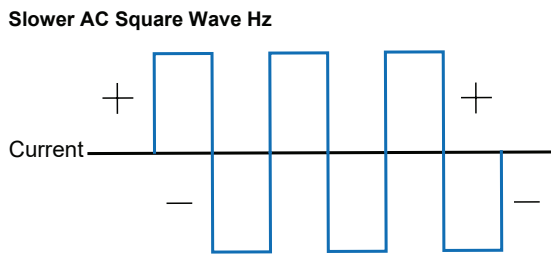
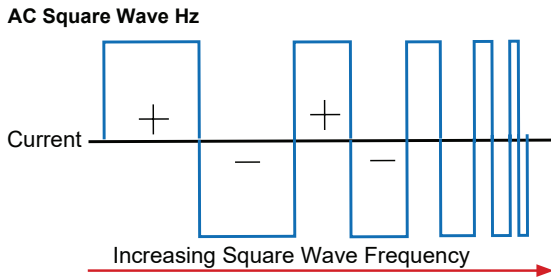

AC (alternating current) enables us to TIG weld non ferrous alloys like Aluminium, Magnesium and Aluminium Alloys. These materials have an insulating surface oxide layer that melts at a higher temperature than the base metal making it difficult to weld the base metal if the oxides are not removed. AC welding current is ideal because the nature of the AC wave form assists in breaking the surface oxide layer.

AC (alternating current) has a current cycle that flows from + (direct) polarity to - (reverse) polarity. The reversing of the polarity breaks the surface oxide while the direct polarity melts the base material.

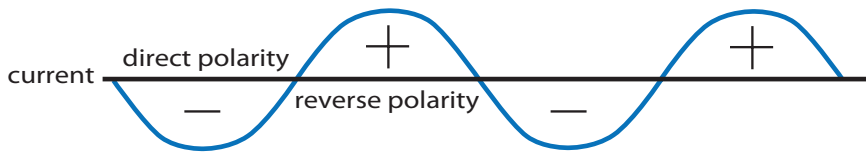

There are inherent problems that come with AC TIG arc rectification, arc stutter, arc wandering and arc stoppage. These problems typically occur during the transition between + and - cycles. The current is less (30%) during the half of the cycle when the electrode is positive and there is a resistance of the electron flow during this half cycle (rectification). The lack of current flow during this half cycle makes the AC arc unstable.

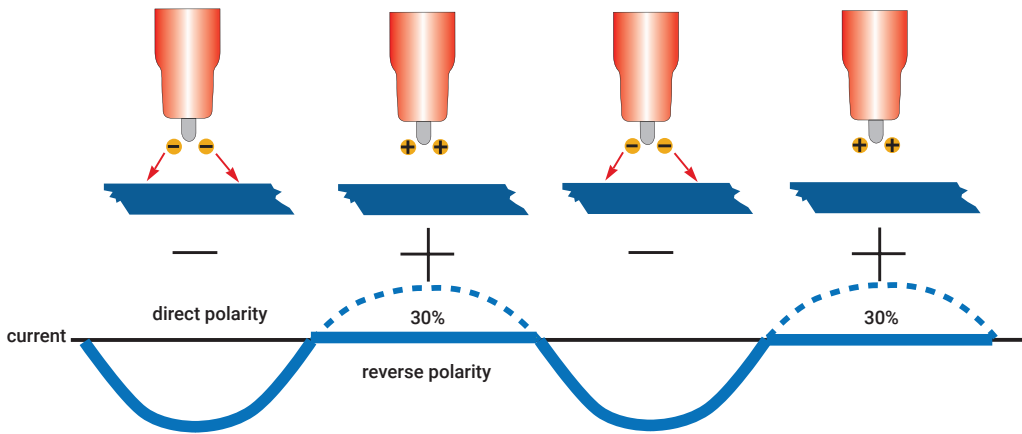

To overcome this lack of flow during one half of the cycle, a high-frequency (HF) voltage is generated and fed into the welding circuit. The HF maintains the arc stability during the half cycle when the electrode is positive.

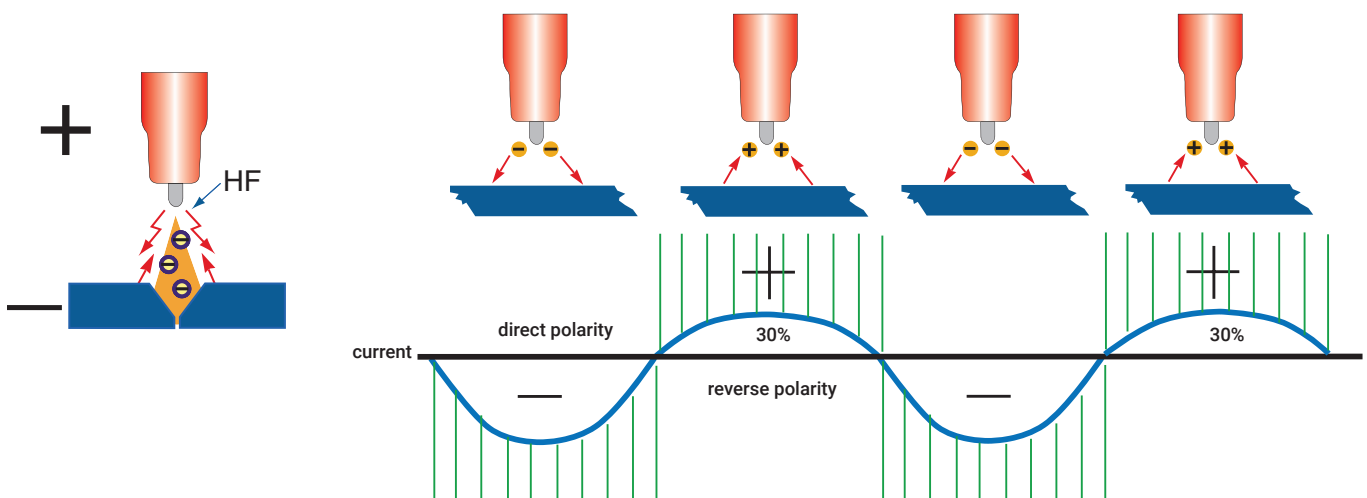

High-frequency voltage flows continually in the welding circuit and keeps the shielding arc in the welding area in an ionized state. When the arc is ionized the arc is maintained during the half of the cycle when the electrode is positive. However while the arc is maintained less current flows during this half of the AC cycle, producing an unbalanced wave.

In older machines, a balanced current output wave was achieved using a large number of capacitors in series or a battery in the welding circuit. Modern TIG power sources use electronics to create and maintain a balanced wave and now most AC TIG power sources produce a square wave current output.

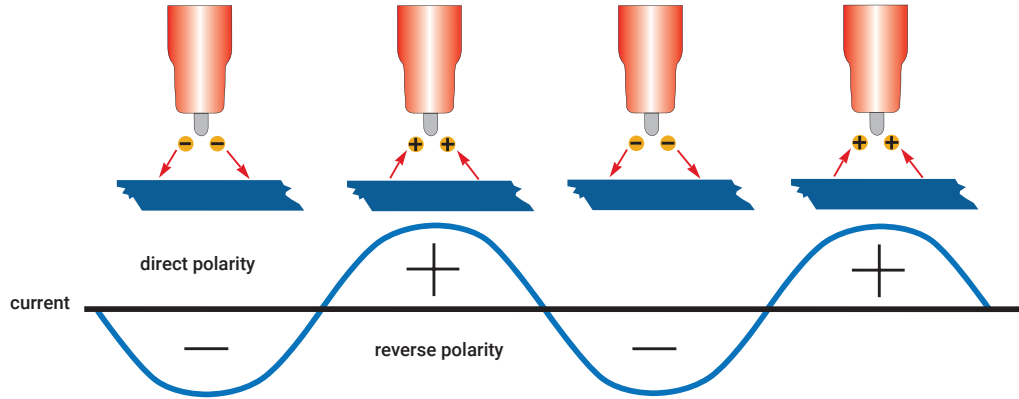

A square wave power supply can change the current from electrode + positive to electrode - negative very quickly. This produces high voltage as the current switches polarities allowing the arc to restart easily. The arc can be maintained without the use of high-frequency or any other arc stabilising methods.

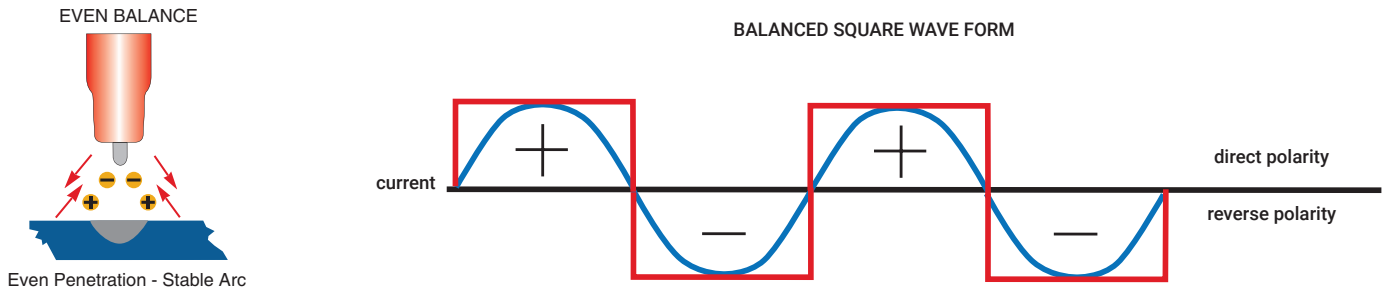

The output current and voltage are controlled electronically so the amount of current electrode positive and the amount of current electrode negative can be adjusted. This allows the welder to adjust the amount of cleaning and the amount of penetration. This is achieved electronically by adjusting the balance control dial on the welding machine. More current flow from the + direct polarity produces stronger arc energy and current flow from the tungsten and is good for removing the oxidized surface of the work piece. However too much + current flow can drive too much energy to the tungsten causing it to overheat and melt the tungsten electrode.

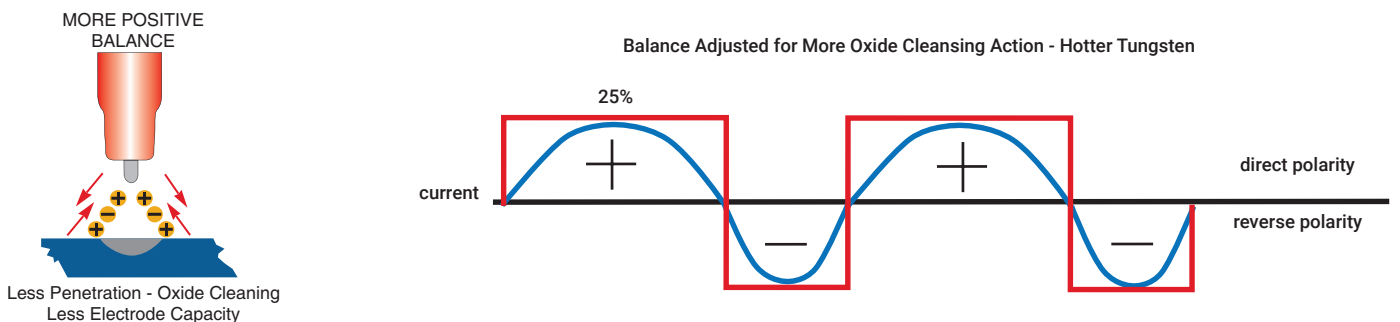
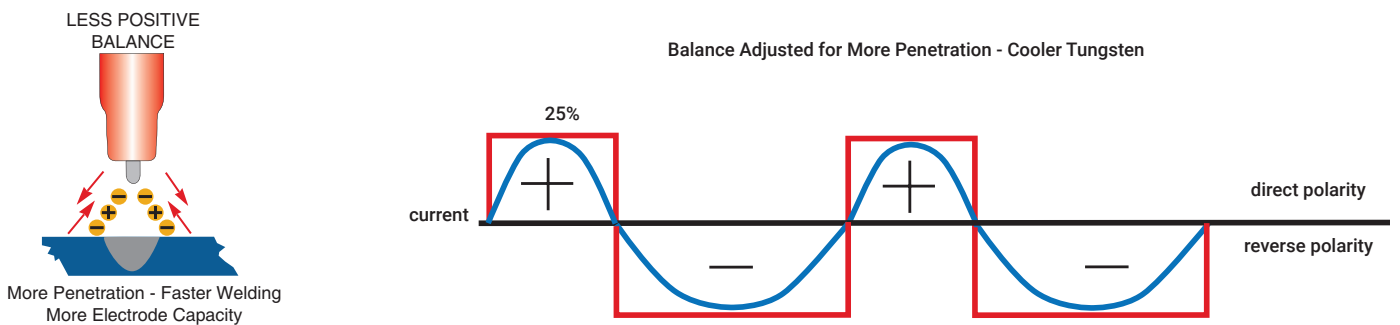

AC PULSE TIG WELDING SET UP PROCEDURE

This machine has digital pulse frequency control. All the parameters for AC Pulse TIG welding - Peak Amp, Base Amp, Pulse Frequency and Pulse Width are easy to set via the digital control panel.

EXAMPLE OF PULSE AC TIG WELDING - SETUP PARAMETERS:

Material = Aluminium x 3.0mm / Tungsten Electrode = 2.4mm Zirconiated / Gas = Argon

The following steps are a guide as a starting point for you to set the machine up in Pulse mode to give an example of welding in Pulse mode function. You can experiment by changing any of the variables to see what effect it has over the welding and what the end result can be, but it is suggested to change only one variable at a time and then check the welding to see what the result is, in this way you acquire a better understanding of how each variable affects the welding current.

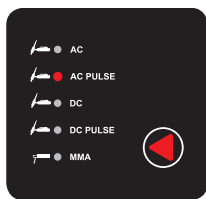

1. Select AC Pulse by pushing selector button to cycle through to illuminate DC Pulse icon.

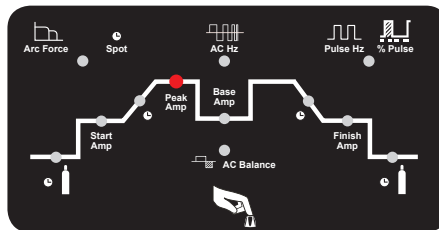

2. Select Peak Amp by pressing the encoder knob to cycle through to illuminate the Peak Amp Icon.



3. Rotate the Encoder Knob to set the Peak Amp at 150A, it will show in the digital display. **(Range is 5-180 Amps)**

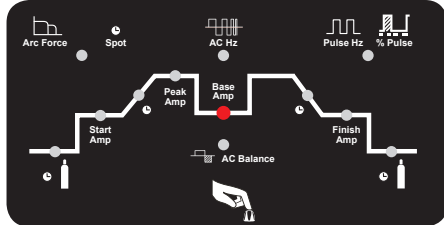

4. Select the Base Amp by pushing the encoder knob to cycle through to illuminate the Base Amp Icon.



5. Rotate the Encoder Knob to set the Base Amp at 60A - **(Range is 5-180 Amps)**

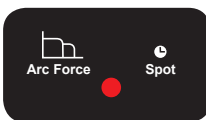
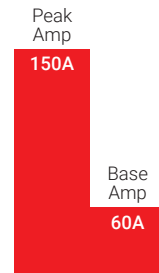

6. Select the Pulse Frequency by pushing the encoder knob to cycle through to illuminate the Pulse Hz Icon.

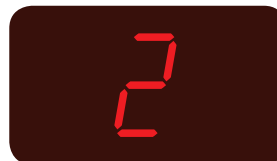

7. Rotate the Adjustment Encoder Knob to set the Pulse Frequency to 2 Hz - **(0.5 - 200Hz)**

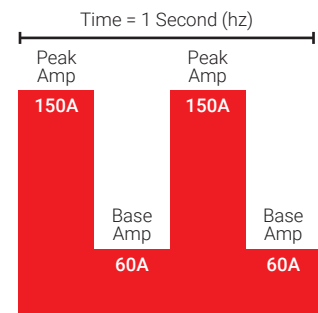

8. Select the Pulse Width (on time of the Peak Amp) by pushing the selector button to cycle through to illuminate the % Pulse Icon.



9. Rotate the Adjustment Encoder Knob to set the Pulse Width at 60% - **(Range is 10 - 90%)**



CONNECTION AND OPERATION OF THE REMOTE FOOT CONTROL UTJRFC-4

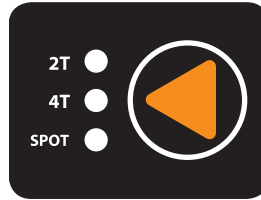

1. Connect the remote control 7 pin plug from the Tig Torch switch lead to the 7 pin remote receptacle on the front panel of the machine.
2. Select 2T trigger function by pushing the button to cycle through until the 2T icon illuminates.
3. Activate by holding down the foot pedal for 5 seconds, the remote icon will illuminate. Up & down travel of the foot pedal will adjust the welding amperage during welding. The side potentiometer knob will allow manual set and adjustment.

Tungsten is a rare metallic element used for manufacturing TIG welding electrodes. The TIG process relies on tungsten's hardness and high-temperature resistance to carry the welding current to the arc. Tungsten has the highest melting point of any metal, 3,410 degrees Celsius.

Tungsten electrodes are nonconsumable and come in a variety of sizes, they are made from pure tungsten or an alloy of tungsten and other rare earth elements. Choosing the correct tungsten depends on the material being welded, the amount of amps required and whether you are using AC or DC welding current.

Tungsten electrodes are colour-coded at the end for easy identification.

Below are the most commonly used tungsten electrodes found in the New Zealand and Australian market.

THORIATED

Thoriated tungsten electrodes (AWS classification EWTh-2) contain a minimum of 97.30 percent tungsten and 1.70 to 2.20 percent thorium and are called 2 percent thoriated. They are the most commonly used electrodes today and are preferred for their longevity and ease of use. Thorium however is a low-level radioactive hazard and many users have switched to other alternatives. Regarding the radioactivity, thorium is an alpha emitter but when it is enclosed in a tungsten matrix the risks are negligible. Thoriated tungsten should not get in contact with open cuts or wounds. The more significant danger to welders can occur when thorium oxide gets into the lungs. This can happen from the exposure to vapours during welding or from ingestion of material/dust in the grinding of the tungsten. Follow the manufacturer's warnings, instructions, and the Material Safety Data Sheet (MSDS) for its use.

E3 (COLOR CODE: PURPLE)

E3 tungsten electrodes (AWS classification EWG) contain a minimum of 98% percent tungsten and up to 1.5 percent Lanthanum and small percentages of Zirconium and Yttrium they are called E3 Tungsten. E3 Tungsten Electrodes provide conductivity similar to that of thoriated electrodes. Typically, this means that E3 Tungsten Electrodes are exchangeable with thoriated electrodes without requiring significant welding process changes. E3 deliver superior arc starting, electrode lifetime, and overall cost-effectiveness. When E3 Tungsten Electrodes are compared with 2% thoriated tungsten, E3 requires fewer re-grinds and provides a longer overall lifetime. Tests have shown that ignition delay with E3 Tungsten Electrodes actually improves over time, while 2% thoriated tungsten starts to deteriorate after only 25 starts. At equivalent energy output, E3 Tungsten Electrodes run cooler than 2% thoriated tungsten, thereby extending overall tip lifetime. E3 Tungsten Electrodes work well on AC or DC. They can be used DC electrode positive or negative with a pointed end, or balled for use with AC power sources.

CERIATED (COLOR CODE: ORANGE)

Ceriated tungsten electrodes (AWS classification EWCe-2) contain a minimum of 97.30 percent tungsten and 1.80 to 2.20 percent cerium and are referred to as 2 percent ceriated. Ceriated tungstens perform best in DC welding at low current settings. They have excellent arc starts at low amperages and become popular in such applications as orbital tube welding, thin sheet metal work. They are best used to weld carbon steel, stainless steel, nickel alloys, and titanium, and in some cases it can replace 2 percent thoriated electrodes. Ceriated tungsten is best suited for lower amperages it should last longer than Thoriated tungsten higher amperage applications are best left to Thoriated or Lanthanated tungsten.

LANTHANATED (COLOR CODE: GOLD)

Lanthanated tungsten electrodes (AWS classification EWL-1.5) contain a minimum of 97.80 percent tungsten and 1.30 percent to 1.70 percent lanthanum, and are known as 1.5 percent lanthanated. These electrodes have excellent arc starting, a low burn off rate, good arc stability, and excellent re-ignition characteristics. Lanthanated tungstens also share the conductivity characteristics of 2 percent thoriated tungsten. Lanthanated tungsten electrodes are ideal if you want to optimise your welding capabilities. They work well on AC or DC electrode negative with a pointed end, or they can be balled for use with AC sine wave power sources. Lanthanated tungsten maintains a sharpened point well, which is an advantage for welding steel and stainless steel on DC or AC from square wave power sources.

ZIRCONIATED (COLOR CODE: WHITE)

Zirconiated tungsten electrodes (AWS classification EWZr-1) contain a minimum of 99.10 percent tungsten and 0.15 to 0.40 percent zirconium. Most commonly used for AC welding Zirconiated tungsten produces a very stable arc and is resistant to tungsten spitting. It is ideal for AC welding because it retains a balled tip and has a high resistance to contamination. Its current-carrying capacity is equal to or greater than that of thoriated tungsten. Zirconiated tungsten is not recommended for DC welding.

TUNGSTEN ELECTRODES RATING FOR WELDING CURRENTS

Tungsten Diameter (mm)	DC Current Amps Torch Negative	AC Current Amps Un-Balanced Wave	AC Current Amps Balanced Wave
	2% Thoriated	0.8% Zirconiated	0.8% Zirconiated
1.0mm	15 - 80	15 - 80	20 - 60
1.6mm	70 - 150	70 - 150	60 - 120
2.4mm	150 - 250	140 - 235	100 - 180
3.2mm	250 - 400	225 - 325	160 - 250
4.0mm	400 - 500	300 - 400	200 - 320

Tungsten Diameter (mm)	Diameter at the Tip (mm)	Constant Included Angle (°)	Current Range (Amps)	Current Range (Pulsed Amps)
1.0mm	0.25	20	11079	22037
1.6mm	0.5	25	18476	05 - 100
1.6mm	0.8	30	25842	10 - 140
2.4mm	0.8	35	33208	12 - 180
2.4mm	1.1	45	15 - 150	15 - 250
3.2mm	1.1	60	20 - 200	20 - 300
3.2mm	1.5	90	25 - 250	25 - 350

TUNGSTEN PREPARATION

Always use DIAMOND wheels when grinding and cutting. While tungsten is a very hard material, the surface of a diamond wheel is harder, and this makes for smooth grinding. Grinding without diamond wheels, such as aluminium oxide wheels, can lead to jagged edges, imperfections, or poor surface finishes not visible to the eye that will contribute to weld inconsistency and weld defects.

Always ensure to grind the tungsten in a longitudinal direction on the grinding wheel. Tungsten electrodes are manufactured with the molecular structure of the grain running lengthwise and thus grinding crosswise is "grinding against the grain." If electrodes are ground crosswise, the electrons have to jump across the grinding marks and the arc can start before the tip and wander. Grinding longitudinally with the grain, the electrons flow steadily and easily to the end of the tungsten tip. The arc starts straight and remains narrow, concentrated, and stable.



ELECTRODE TIP/FLAT

The shape of the tungsten electrode tip is an important process variable in precision arc welding. A good selection of tip/flat size will balance the need for several advantages. The bigger the flat, the more likely arc wander will occur and the more difficult it will be to arc start. However, increasing the flat to the maximum level that still allows arc start and eliminates arc wander will improve the weld penetration and increase the electrode life. Some welders still grind electrodes to a sharp point, which makes arc starting easier. However, they risk decreased welding performance from melting at the tip and the possibility of the point falling off into the weld pool.



ELECTRODE INCLUDED ANGLE/TAPER - DC WELDING

Tungsten electrodes for DC welding should be ground longitudinally and concentrically with diamond wheels to a specific included angle in conjunction with the tip/flat preparation. Different angles produce different arc shapes and offer different weld penetration capabilities. In general, blunter electrodes that have a larger included angle provide the following benefits:

- Last Longer
- Have better weld penetration
- Have a narrower arc shape
- Can handle more amperage without eroding.

Sharper electrodes with smaller included angle provide:

- Offer less arc weld
- Have a wider arc
- Have a more consistent arc

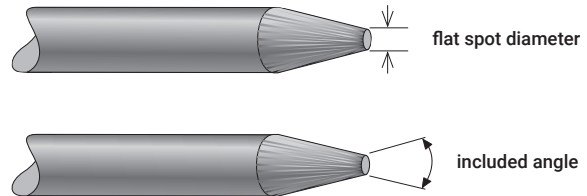

The included angle determines weld bead shape and size. Generally, as the included angle increases, penetration increases and bead width decreases.

TUNGSTEN PREPARATION AC WELDING

To obtain full current capacity from a pure or zirconiated tungsten electrode when used with AC current output the electrode is not ground to a point. The welding during positive polarity melts the point of the tungsten that becomes rounded. The ball shape formed at the end of the tungsten is desirable because it reduces current rectification and allows the arc to flow more easily.

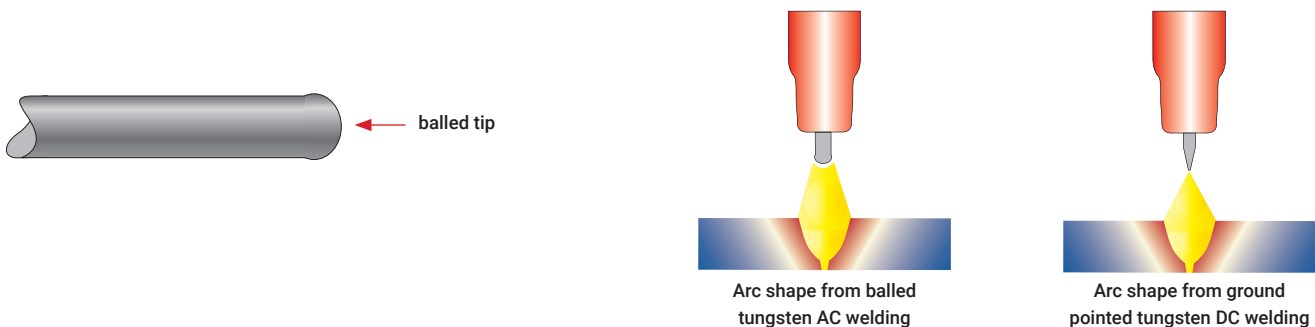

SAFETY WITH TUNGSTEN ELECTRODES

Tungsten welding electrodes should never be manually ground on an abrasive belt or wheel (particularly silicone carbide). Always use diamond wheels when grinding and cutting tungstens. The risk of injury when hand (manually) grinding a very hard brittle material like tungsten is quite high. It is important to always follow standard safety guidelines when operating high speed grinding equipment.

- Wear approved safety glasses
- No loose clothing which may get caught in moving parts
- Wear protective hair covering to contain long hair
- Wear safety shoes with non-slip sole
- A vacuum system is recommended to remove tungsten, especially thorium dust
- Never operate power tools when tired, intoxicated or when taking medication that causes drowsiness

The most common injuries to the manual tungsten electrode grinder are eye and finger related. Holding and grinding the tungsten electrode by hand has resulted in burned fingers, laceration to fingers and splintered tungsten electrodes in hand or fingers. Eye injury generally occurs from manually grinding tungsten electrodes without a safety shield or safety glasses. Small slivers of tungsten electrode may become stuck in the operator's eye.

MMA (STICK) WELDING SET UP

1. Turn the power source on, and select 'MMA' from the weld process selector.

2. Connection of Output Cables

Two sockets are available on this welding machine. For MMA welding the electrode holder is shown be connected to the positive socket, while the earth lead (work piece) is connected to the negative socket, this is known as DC+ polarity. However various electrodes require a different polarity for optimum results and careful attention should be paid to the polarity, refer to the electrode manufacturers information for the correct polarity.

DC+ Electrode connected to (+) output socket.

DC- Electrode connected to (-) output socket.



(3a) Push the encoder knob until 'Peak Amp' illuminates, then turn the knob to set the desired amperage.

(3b) Push the encoder knob until 'Arc Force' illuminates, then turn the knob to set the desired Arc Force Vale



(4) Place the electrode into the electrode holder and clamp tight.



(5) Strike the electrode against the work-piece to create an arc and hold the electrode steady to maintain the arc.



(6) Hold the electrode slightly above the work maintaining the arc while travelling at an even speed.



(7) To finish the weld, break the arc by quickly snapping the electrode away from the work piece.



(8) Wait for the weld to cool and carefully chip away the slag to reveal the weld metal below.

MMA (MANUAL METAL ARC) WELDING

One of the most common types of arc welding is manual metal arc welding (MMA) or MMA welding. An electric current is used to strike an arc between the base material and a consumable electrode rod or 'stick'. The electrode rod is made of a material that is compatible with the base material being welded and is covered with a flux that gives off gaseous vapours that serve as a shielding gas and providing a layer of slag, both of which protect the weld area from atmospheric contamination. The electrode core itself acts as filler material the residue from the flux that forms a slag covering over the weld metal must be chipped away after welding.

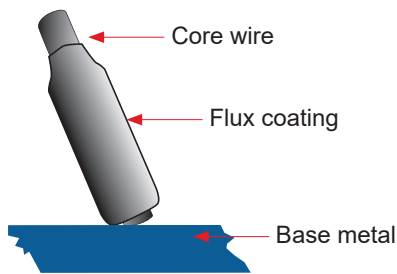
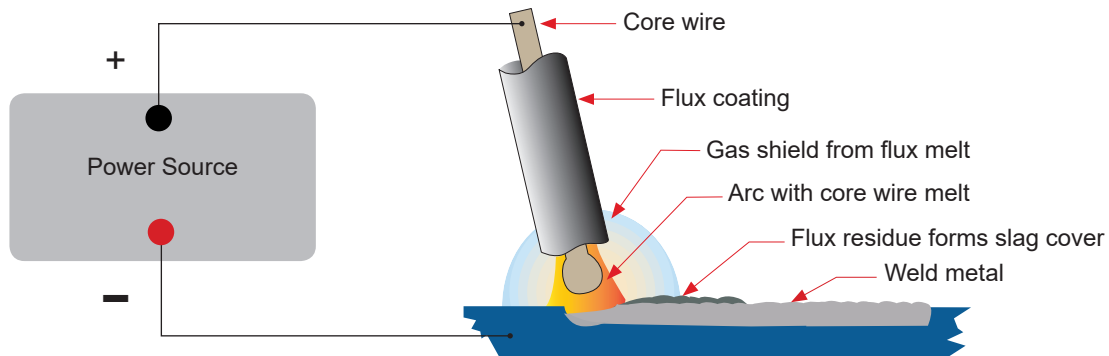

- The arc is initiated by momentarily touching the electrode to the base metal.
- The heat of the arc melts the surface of the base metal to form a molten pool at the end of the electrode.
- The melted electrode metal is transferred across the arc into the molten pool and becomes the deposited weld metal.
- The deposit is covered and protected by a slag which comes from the electrode coating.
- The arc and the immediate area are enveloped by an atmosphere of protective gas

Manual metal arc (stick) electrodes have a solid metal wire core and a flux coating. These electrodes are identified by the wire diameter and by a series of letters and numbers. The letters and numbers identify the metal alloy and the intended use of the electrode.

The Metal Wire Core works as conductor of the current that maintains the arc. The core wire melts and is deposited into the welding pool.

The covering on a shielded metal arc welding electrode is called Flux. The flux on the electrode performs many different functions.

These include:

- Producing a protective gas around the weld area
- Providing fluxing elements and de-oxidisers
- Creating a protective slag coating over the weld as it cools
- Establishing arc characteristics
- Adding alloying elements.

Covered electrodes serve many purposes in addition to adding filler metal to the molten pool. These additional functions are provided mainly by the covering on the electrode.

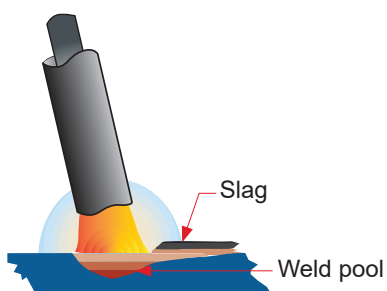
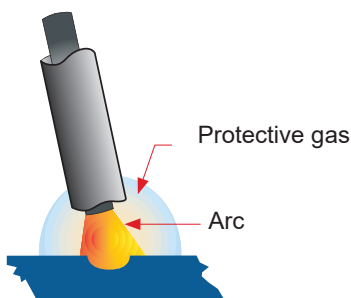

MMA (STICK) WELDING FUNDAMENTALS

ELECTRODE SELECTION

As a general rule, the selection of an electrode is straight forward, in that it is only a matter of selecting an electrode of similar composition to the parent metal. However, for some metals there is a choice of several electrodes, each of which has particular properties to suit specific classes of work. It is recommended to consult your welding supplier for the correct selection of electrode.

Average Thickness of Material	Maximum Recommended Electrode Diameter
1.0 - 2.0mm	2.5mm
2.0 - 5.0mm	3.2mm
5.0 - 8.0mm	4.0mm
8.0 - > mm	5.0mm

Electrode Size (ø mm)	Current Range (Amps)
2.5mm	60 - 100
3.2mm	100 - 130
4.0mm	130 - 165
5.0mm	165 - 260

The size of the electrode generally depends on the thickness of the section being welded, and the thicker the section the larger the electrode required. The table gives the maximum size of electrodes that may be used for various thicknesses of section based on using a general purpose type 6013 electrode.

Correct current selection for a particular job is an important factor in arc welding. With the current set too low, difficulty is experienced in striking and maintaining a stable arc. The electrode tends to MMA to the work, penetration is poor and beads with a distinct rounded profile will be deposited. Too high current is accompanied by overheating of the electrode resulting in undercut and burning through of the base metal and producing excessive spatter. Normal current for a particular job may be considered as the maximum, which can be used without burning through the work, over-heating the electrode or producing a rough spattered surface. The table shows current ranges generally recommended for a general purpose type 6013 electrode.

ARC LENGTH

To strike the arc, the electrode should be gently scraped on the work until the arc is established. There is a simple rule for the proper arc length; it should be the shortest arc that gives a good surface to the weld. An arc too long reduces penetration, produces spatter and gives a rough surface finish to the weld. An excessively short arc will cause sticking of the electrode and result in poor quality welds. General rule of thumb for down hand welding is to have an arc length no greater than the diameter of the core wire.

ELECTRODE ANGLE

The angle that the electrode makes with the work is important to ensure a smooth, even transfer of metal. When welding in down hand, fillet, horizontal or overhead the angle of the electrode is generally between 5 and 15 degrees towards the direction of travel. When vertical up welding the angle of the electrode should be between 80 and 90 degrees to the work piece.

TRAVEL SPEED

The electrode should be moved along in the direction of the joint being welded at a speed that will give the size of run required. At the same time, the electrode is fed downwards to keep the correct arc length at all times. Excessive travel speeds lead to poor fusion, lack of penetration etc, while too slow a rate of travel will frequently lead to arc instability, slag inclusions and poor mechanical properties.

MATERIAL AND JOINT PREPARATION

The material to be welded should be clean and free of any moisture, paint, oil, grease, mill scale, rust or any other material that will hinder the arc and contaminate the weld material. Joint preparation will depend on the method used include sawing, punching, shearing, machining, flame cutting and others. In all cases edges should be clean and free of any contaminants. The type of joint will be determined by the chosen application.

T2 TIG TORCH | HIGH PERFORMANCE SERIES

AIR COOLED TIG WELDING TORCH

RATING: 190A DC / 135A AC @35% DUTY CYCLE. 1.6 TO 3.2MM ELECTRODE

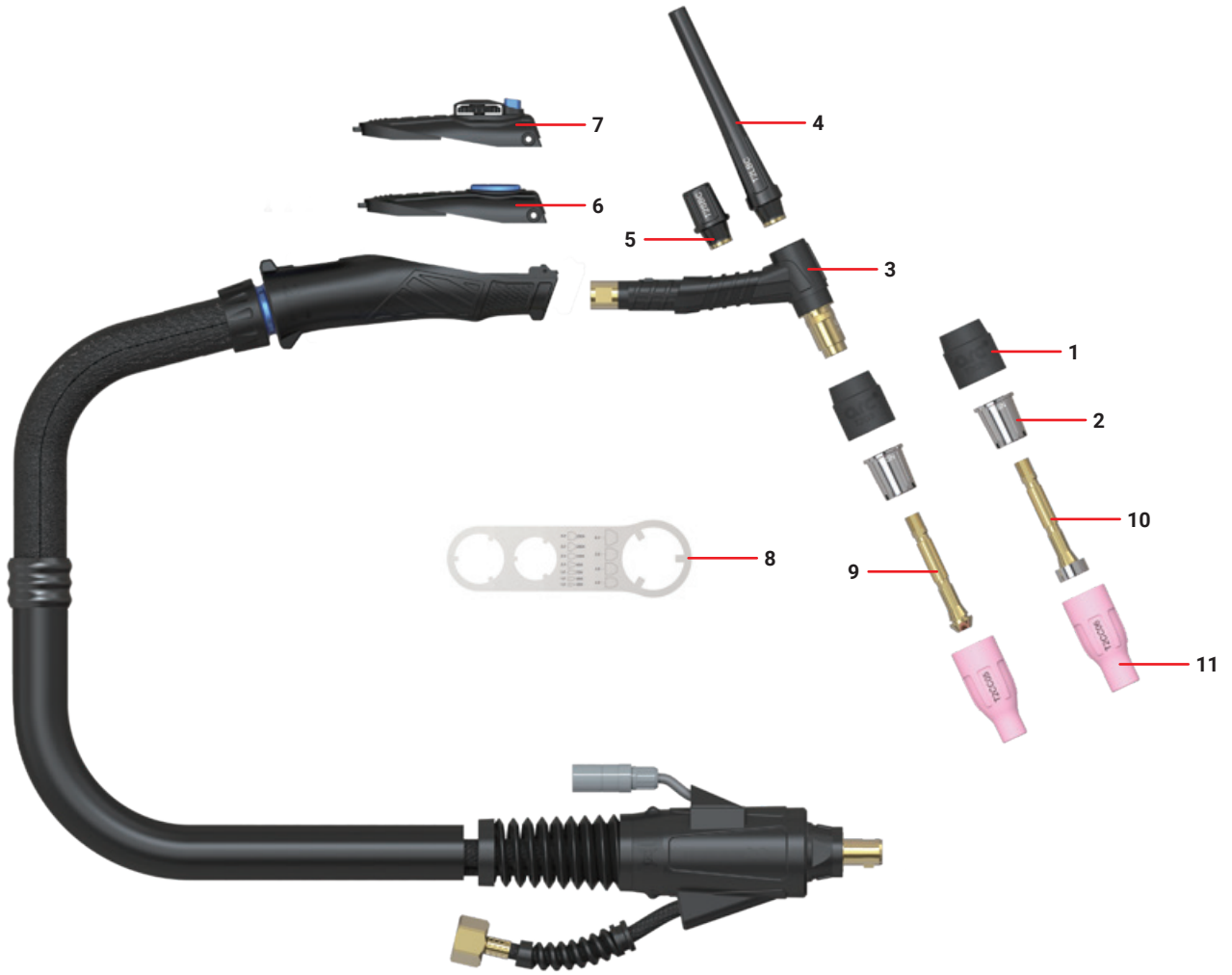

	Part No.	
Length	4m	8m
T2 TIG Torch	T2-S1-4M-SL-GS1	T2-S1-8M-SL-GS1

Part-No	Description
1	UM-C-T2HG T2/T3W HEAD GASKET
2	UM-C-T2SN T2/T3W HEAT ZONE ISOLATOR
3	UM-C-T2TH-F T2 TORCH HEAD "FLEXIBLE HEAD"
4	UM-C-T2LBC T2/T3W LONG BACK CAP
5	UM-C-T2SBC T2/T3W SHORT BACK CAP
6	UM-C-TMS 1 BUTTON MOMENTARY

Part-No	Description
7	UM-C-TMK-10KP 10K POTENTIOMETER
8	UM-C-TSPAN SPANNER
9	See following page Collet Body
10	See following page Gas Lens Collet Body
11	See following page Ceramic Cup

T2 FRONT END CONSUMABLES

COLLET BODY

Part-No	Description	Bore Size	QTY
UM-C-T2CB10	T2/T3W Collet Body	1.6mm	1
UM-C-T2CB16	T2/T3W Collet Body	2.0mm	1
UM-C-T2CB24	T2/T3W Collet Body	2.4mm	1
UM-C-T2CB32	T2/T3W Collet Body	3.2mm	1



GAS LENS COLLET BODY

Part-No	Description	Bore Size	QTY
UM-C-T2GL10	T2/T3W Gas Lens Collet Body	1.6mm	1
UM-C-T2GL16	T2/T3W Gas Lens Collet Body	2.0mm	1
UM-C-T2GL24	T2/T3W Gas Lens Collet Body	2.4mm	1
UM-C-T2GL32	T2/T3W Gas Lens Collet Body	3.2mm	1



CERAMIC CUP

Part-No	Description	Nozzle	Bore Size	QTY
UM-C-T2C04	T2/T3W Ceramic Cup	#4	6mm	1
UM-C-T2C05	T2/T3W Ceramic Cup	#5	8mm	1
UM-C-T2C06	T2/T3W Ceramic Cup	#6	10mm	1
UM-C-T2C07	T2/T3W Ceramic Cup	#7	11mm	1
UM-C-T2C08	T2/T3W Ceramic Cup	#8	12.5mm	1
UM-C-T2C10	T2/T3W Ceramic Cup	#10	16mm	1



WC20 2.0% CERIATED TUNGSTEN ELECTRODE



Part-No	Description	QTY
TR0003-10	1.0mm x 175mm ceriated tungsten electrode 2.0%	10
TR0003-16	1.6mm x 175mm ceriated tungsten electrode 2.0%	10
TR0003-24	2.4mm x 175mm ceriated tungsten electrode 2.0%	10
TR0003-32	3.2mm x 175mm ceriated tungsten electrode 2.0%	10



WT20 2% THORIATED TUNGSTEN ELECTRODE



Part-No	Description	QTY
TR0004-10	1.0mm x 175mm thoriated tungsten electrode 2%	10
TR0004-16	1.6mm x 175mm thoriated tungsten electrode 2%	10
TR0004-24	2.4mm x 175mm thoriated tungsten electrode 2%	10
TR0004-32	3.2mm x 175mm thoriated tungsten electrode 2%	10



E3 1.5% LANTHANUM TUNGSTEN ELECTRODE



98% percent tungsten and up to 1.5 percent Lanthanum and small percentages of Zirconium and Yttrium

Part-No	Description	QTY
TR0005-10	1.0mm x 175mm lanthanum tungsten electrode 1.5%	10
TR0005-16	1.6mm x 175mm lanthanum tungsten electrode 1.5%	10
TR0005-24	2.4mm x 175mm lanthanum tungsten electrode 1.5%	10
TR0005-32	3.2mm x 175mm lanthanum tungsten electrode 1.5%	10



WZ8 0.8% ZIRCONIATED TUNGSTEN ELECTRODE



Part-No	Description	QTY
TR0006-10	1.0mm x 175mm zirconiated tungsten electrode 0.8%	10
TR0006-16	1.6mm x 175mm zirconiated tungsten electrode 0.8%	10
TR0006-24	2.4mm x 175mm zirconiated tungsten electrode 0.8%	10
TR0006-32	3.2mm x 175mm zirconiated tungsten electrode 0.8%	10



TIG WELDING TROUBLE SHOOTING

The following chart addresses some of the common problems of TIG welding. In all cases of equipment malfunction, the manufacturer's recommendations should be strictly adhered to and followed.

1: Tungsten burning away quickly	
Possible Reason	Suggested Remedy
Incorrect Gas or No Gas	Use pure Argon. Check cylinder has gas, connected, turned on and torch valve is open
Inadequate gas flow	Check the gas is connected, check hoses, gas valve and torch are not restricted.
Back cap not fitted correctly	Make sure the torch back cap is fitted so that the o-ring is inside the torch body
Torch connected to DC +	Connect the torch to the DC- output terminal
Incorrect tungsten being used	Check and change the tungsten type if necessary
Tungsten being oxidised after weld is finished	Keep shielding gas flowing 10–15 seconds after arc stoppage. 1 second for each 10 amps of weld current.
Inadequate gas flow or too much gas flow	Check the gas is connected, check hoses, gas valve and torch are not restricted. Set the gas flow between 6-12 l/min flow rate. Check hoses and fittings for holes, leaks etc Protect the welding zone from wind and drafts
2: Contaminated tungsten	
Possible Reason	Suggested Remedy
Touching tungsten into the weld pool	Keep tungsten from contacting weld puddle. Raise the torch so that the tungsten is off of the work piece 2 - 5mm
Touching the filler wire to the tungsten	Keep the filler wire from touching the tungsten during welding, feed the filler wire into the leading edge of the weld pool in front of the tungsten.
3: Porosity - poor weld appearance and colour	
Possible Reason	Suggested Remedy
Wrong gas / poor gas flow /gas leaks	Use pure argon. Gas is connected, check hoses, gas valve and torch are not restricted. Set the gas flow between 6-12 l/min. Check hoses and fittings for holes, leaks etc.,
Contaminated base metal	Remove moisture and materials like paint, grease, oil, and dirt from base metal
Contaminated filler wire	Remove all grease, oil, or moisture from filler metal.
Incorrect filler wire	Check the filler wire and change if necessary
4: Yellowish residue / smoke on the alumina nozzle & discoloured tungsten	
Possible Reason	Suggested Remedy
Incorrect Gas	Use pure Argon gas
Inadequate gas flow	Set the gas flow between 10 - 15 l/min flow rate
Alumina gas nozzle too small	Increase the size of the alumina gas nozzle
5: Unstable Arc during DC welding	
Possible Reason	Suggested Remedy
Torch connected to DC +	Connect the torch to the DC- output terminal
Contaminated base metal	Remove materials like paint, grease, oil, and dirt, including mill scale from base metal.
Tungsten is contaminated	Remove 10mm of contaminated tungsten and re grind the tungsten
Arc length too long	Lower torch so that the tungsten is off of the work piece 2 - 5mm
6: Arc wanders during DC welding	
Possible Reason	Suggested Remedy
Poor gas flow	Check and set the gas flow between 10 - 15 l/min flow rate
Incorrect arc length	Lower torch so that the tungsten is off of the work piece 2 - 5mm
Tungsten incorrect or in poor condition	Check that correct type of tungsten is being used. Remove 10mm from the weld end of the tungsten and re sharpen the tungsten
Poorly prepared tungsten	Grind marks should run lengthwise with tungsten, not circular. Use proper grinding method and wheel.
Contaminated base metal or filler wire	Remove contaminating materials like paint, grease, oil, and dirt, including mill scale from base metal. Remove all grease, oil, or moisture from filler metal.
7: Arc difficult to start or will not start DC welding	
Possible Reason	Suggested Remedy
Incorrect machine set up	Check machine set up is correct
No gas, incorrect gas flow	Check the gas is connected and cylinder valve open, check hoses, gas valve and torch are not restricted. Set the gas flow between 10 - 15 l/min flow rate
Incorrect tungsten size or type	Check and change the size and or the tungsten if required
Loose connection	Check all connectors and tighten
Earth clamp not connected to work	Connect the earth clamp directly to the work piece wherever possible

MMA (STICK) WELDING TROUBLE SHOOTING

The following chart addresses some of the common problems of MMA welding. In all cases of equipment malfunction, the manufacturer's recommendations should be strictly adhered to and followed.

1: No arc	
Possible Reason	Suggested Remedy
Incomplete welding circuit	Check earth lead is connected. Check all cable connections.
Wrong mode selected	Check the MMA selector switch is selected
No power supply	Check that the machine is switched on and has a power supply
2: Porosity – small cavities or holes resulting from gas pockets in weld metal.	
Possible Reason	Suggested Remedy
Arc length too long	Shorten the arc length
Work piece dirty, contaminated or moisture	Remove moisture and materials like paint, grease, oil, and dirt, including mill scale from base metal
Damp electrodes	Use only dry electrodes
3: Excessive Spatter	
Possible Reason	Suggested Remedy
Amperage too high	Decrease the amperage or choose a larger electrode
Arc length too long	Shorten the arc length
3: Weld sits on top, lack of fusion	
Possible Reason	Suggested Remedy
Insufficient heat input	Increase the amperage or choose a larger electrode
Work piece dirty, contaminated or moisture	Remove moisture and materials like paint, grease, oil, and dirt, including mill scale from base metal
Poor welding technique	Use the correct welding technique or seek assistance for the correct technique
4: Lack of penetration	
Possible Reason	Suggested Remedy
Insufficient heat input	Increase the amperage or choose a larger electrode
Poor welding technique	Use the correct welding technique or seek assistance for the correct technique
Poor joint preparation	Check the joint design and fit up, make sure the material is not too thick. Seek assistance for the correct joint design and fit up
5: Excessive penetration - burn through	
Possible Reason	Suggested Remedy
Excessive heat input	Reduce the amperage or use a smaller electrode
Incorrect travel speed	Try increasing the weld travel speed
6: Uneven weld appearance	
Possible Reason	Suggested Remedy
Unsteady hand, wavering hand	Use two hands where possible to steady up, practise your technique
7: Distortion – movement of base metal during welding	
Possible Reason	Suggested Remedy
Excessive heat input	Reduce the amperage or use a smaller electrode
Poor welding technique	Use the correct welding technique or seek assistance for the correct technique
Poor joint preparation and or joint design	Check the joint design and fit up, make sure the material is not too thick. Seek assistance for the correct joint design and fit up
7: Electrode welds with different or unusual arc characteristic	
Possible Reason	Suggested Remedy
Incorrect polarity	Change the polarity, check the electrode manufacturer for correct polarity

WARRANTY TERMS



Welding Guns Of Australia Pty Ltd ('Us', 'We') warrants that the following products under UNIMIG, UNI-TIG, UNI-PLAS, UNI-FLAME, TECNA, T&R, HIT-8SS & ROTA, supplied by Us and purchased by you from an Authorised UNIMIG, UNI-TIG, UNI-PLAS, UNI-FLAME, TECNA, T&R, HIT-8SS & ROTA Dealer throughout Australia are free of Material and Faulty Workmanship defects except for those products listed under 'Warranty Exclusions'.

These terms and conditions supersede and exclude all former and other representations and arrangements relating to any warranties on these products.

WARRANTY PERIOD

We offer the following 'Warranty Periods' from 'date of purchase':

An Extended Warranty Period of 6 months total shall apply only to Machinery where offered and warranty is registered online.

UNIMIG WELDING MACHINES

UNIMIG DIY Series (Power Source Only)	2 Years	(Clause 3)
UNIMIG Procraft Series (Power Source Only)	3 Years	(Clause 1&3)
UNIMIG Trade Series (Power Source Only)	3 Years	(Clause 1&3)
UNIMIG Trade Series SWF (Power Source / Separate Wire Feeder Only)	3 Years	(Clause 1&3)
UNIMIG Workshop Series (Power Source Only)	3 Years	(Clause 1&3)
UNIMIG Workshop Series SWF (Power Source / Separate Wire Feeder Only)	3 Years	(Clause 1&3)
UNIMIG Jasic Inverter MIG (Power Source Only)	3 Years	(Clause 3)
UNIMIG Jasic Inverter MIG SWF (Power Source / Separate Wire Feeder Only)	3 Years	(Clause 3)
UNI-TIG Jasic Inverter TIG (Power Source Only)	3 Years	(Clause 3)
UNIMIG Water Cooler	1 Year	(Clause 3)
T&R Pulse MIG (Power Source Only)	2 Year	(Clause 3)
T&R Pulse MIG SWF (Power Source / Separate Wire Feeder Only)	2 Year	(Clause 3)
UNI-PLAS (Power Source Only)	3 Years	(Clause 3)
UNI-PLAS Jasic Series (Power Source Only)	2 Years	(Clause 3)
UNI-PLAS Site Cut Series (Power Source Only)	1 Year	(Clause 3)
UNI-FLAME Gas Cutting and Welding Kits	3 Months	(Clause 2&3)
UNI-FLAME Straight Line & Gas Cutting Machines (Power Source Only)	1 Year	(Clause 3)
UNI-FLAME Regulators Argon/ Acetylene / Oxygen / LPG / Bobbin Flowmeter	1 Year	
UNI-FLAME Automatic Welding Helmet	2 Years	
UNIMIG Automatic Welding Helmets	2 Years	
TECNA (Power Source Only)	1 Year	(Clause 3)
HIT-8SS Automatic Carriage (Power Source Only)	1 Year	(Clause 3)
ROTA 102 Rotating table	1 Year	
HOTBOX Electrode Oven	1 Year	
SPOTCAR 3500	1 Year	(Clause 3)
TORCHES -GMAW, GTAW, MMAW, PLASMA, EARTH LEADS, INTERCONNECTING CABLES, GAS HOSE	3 Months	(Clause 3)
UNIMIG VIPER RANGE	1 Year	
UNIMIG VIPER MIG 185 / VIPER TIG 180 AC/DC	2 Years	

(Clause 1) 3 year warranty on transformers, inductor and rectifier. 1 year warranty on PCB, and all other components, .

(Clause 2) Gas Hose, Flashbacks are subject to and covered by the Manufacturer's Individual Warranty, Contact the manufacturer for details

(Clause 3) This only Covers Manufactures defaults on all accessories for the first three months after date of purchase.

WARRANTY / RETURNS / EXCHANGES

We understand that sometimes you may need to return a product you have purchased from Welding Guns Of Australia PTY LTD Authorised Dealer Network, to assist you, we have set out below the Welding Guns Of Australia PTY LTD Returns Policy that you should know.

Our Returns Policy includes the rights you have under the Australian Consumer Law and other relevant laws.

Your Rights under the Australian Consumer Law - Our goods come with guarantees that cannot be excluded under the Australian Consumer Law. You are entitled to a replacement or refund for a major failure and for compensation for any other reasonably foreseeable loss or damage. You are also entitled to have the goods repaired or replaced if the goods fail to be of acceptable quality and the failure does not amount to a major failure.

- You shall inspect the Goods on delivery and shall within seven (7) days of delivery (time being of the essence) notify Welding Guns Of Australia PTY LTD of any alleged defect, shortage in quantity, damage or failure to comply with the description or quote.
- You shall also afford Welding Guns Of Australia PTY LTD the opportunity to inspect the Goods within a reasonable time following delivery if you believe the Goods are defective in any way.
- If you shall fail to comply with these provisions the Goods shall be presumed to be free from any defect or damage. For defective Goods, which Welding Guns Of Australia PTY LTD has agreed in writing that you are entitled to reject, Welding Guns Of Australia PTY LTD liability is limited to either (at the Welding Guns Of Australia PTY LTD discretion) replacing the Goods or repairing the Goods except where you have acquired Goods as a consumer within the meaning of the Trade Practices Act 1974 or the Fair Trading Acts of the relevant state or territories of Australia, and is therefore also entitled to, at the consumer's discretion either a refund of the purchase price of the Goods, or repair of the Goods, or replacement of the Goods.

Returns will only be accepted provided that:

- a. You have complied with the provisions outlined above, and
 - b. Where the Goods are unable to be repaired, the Goods are returned at your cost within thirty (30) days of the delivery date, and
 - c. Welding Guns Of Australia PTY LTD will not be liable for Goods which have not been stored or used in a proper manner, and
 - d. The Goods are returned in the condition in which they were delivered and with all packaging material, brochures and instruction material in as new condition as is reasonably possible in the circumstances.
- Welding Guns Of Australia PTY LTD Accepts no responsibility for products lost, damaged or mislaid whilst in transit
 - Welding Guns Of Australia PTY LTD may (at their sole discretion) accept the return of Goods for credit but this may incur a handling fee of up to fifteen percent (15%) of the value of the returned Goods plus any freight costs.
 - Where a failure does not amount to a major failure, Welding Guns Of Australia PTY LTD is entitled to choose between providing you with a repair, replacement or other suitable remedy.
 - Your rights under the Australian Consumer Law are not limited by a defined time. However, the Australian Consumer Law does recognise that the relevant time period can vary from product to product, depending on factors such as the nature of the product and the price. Welding Guns Of Australia PTY LTD adopts the same approach. As you can appreciate, the type of remedy we can offer you may also vary depending on how long it takes you to return the product to us.

MAKING A CLAIM

If you wish to make a claim under this Warranty, you should:

- Return the product to the point of purchase either in person or on a prepaid courier; or
- Contact Us by Telephone on 02 9870 4200 or Mail PO Box 3033 Lansvale NSW 2166.

When returned, the product must be accompanied with the original invoice including the purchase price and disclosing the purchase date

All costs of installation, cartage, freight, travelling expenses, hiring tools and insurance are paid by the Customer.

To the extent permitted by law, our total liability for loss or damage of every kind related to the product in any way whatsoever is limited to the amount paid to the retailer by you for the product or the value of the product.

No responsibility will be taken for products lost, damaged or mislaid whilst in transit.

WARRANTY EXCLUSIONS

This Warranty covers Material and Faulty Workmanship defects only.

This Warranty does not cover damage caused by:

- Normal wear and tear due to usage
- Misuse or abusive use of the UNIMIG, UNI-TIG, UNI-PLAS, UNI-FLAME, TECNA, T&R, HIT-8SS & ROTA, instructions supplied with the product.
- Failure to clean or improper cleaning of the product
- Failure to maintain the equipment such as regular services etc
- Incorrect voltage or non-authorised electrical connections
- Improper installation
- Use of non-authorised/non-standard parts
- Abnormal product performance caused by any ancillary equipment interference or other external factors
- Failure or any breakage caused by overload, dropping or abusive treatment or use by the customer
- Repair, modifications or other work carried out on the product other than by an Authorised UNIMIG, UNI-TIG, UNI-PLAS, UNI-FLAME, TECNA, T&R, HIT-8SS & ROTA Service Dealer

Unless it is a manufacturing fault, this Warranty does not cover the following parts:

MIG Welding Torches and Consumables to suit, such as:

Gas Nozzles, Gas Diffusers, Contact Tip holder, Contact tip, Swan Necks, Trigger, Handle, Liners, Wire Guide, Drive Roller, Gas Nozzle Spring, Neck Spring, Connector Block, Insulator, Gas Nipple, Cap, Euro Block, Head Assembly, Gas Block, Trigger Spring, Spring Cable Support, Neck Insulator, Shroud Spring, Gun Plug Cover, Lock Nut, Snap On Head, Spring Cap, Ball, Motor 42 Volt, Pot 10K standard, Knob, Drive Roll Seat, Washer, Bow, Ball Bearing, Wire Conduit Nipple, Central Plug, Printed Circuit Board, Gun Plug House, Cable Support, Gas Connector, Handle To Suit PP36 with Knobs, All Xcel-Arc/ Magmaweld MIG Welding Wires & Electrodes, Arc Leads, Welding Cable, Electrode Holder, Earth Clamps

TIG Welding Torches and Consumables to suit, such as:

Tungsten Electrodes, Collet, Collet Body, Alumina Nozzle, Torch Head, Torch Head water Cooled, Torch Head Flexible, Back Caps, Gas Lens, Torch Handle, Cup Gasket, Torch Body Gas Valve, O-ring, All UNIMIG TIG Welding Rods, All Xcel-Arc/ Magmaweld Electrodes, Arc Leads, Welding Cable, Electrode Holder, Earth Clamps.

PLASMA Cutting Torches and Consumables to suit, such as:

All Cutting Tips, All Diffuser/Swirl Ring, All Electrode, Retaining Caps, Nozzle Springs, All Spacers, All Shield Caps, All Air and Power Cables, All Switches, All O-rings, All Springs, All Circle Guides and Cutting Kits, Torch Bodies, Air Filter Regulator, Arc Leads, Welding Cable, Electrode Holder, Earth Clamps

STRAIGHT LINE CUTTING MACHINES and Consumables to suit, such as:

Hoses, Fittings, Track, Cutting Nozzles.

HIT-8SS Welding Carriage Consumables to suit, such as:

Input Cord, Inter-connecting Cord, Triggering Cable.

This Warranty does not cover products purchased:

- From a non-authorised UNIMIG, UNI-TIG, UNI-PLAS, UNI-FLAME, TECNA, T&R, HIT-8SS & ROTA Dealer (such as purchases from unauthorised retailers and purchases over the Internet from unauthorised local/international sellers or sites such as eBay)
- At an auction;
- From a private seller

Unless it is a manufacturing fault, this Warranty does not apply to any products sold to Hire Companies.

These conditions may only be varied with the written approval of the Directors of Welding Guns Of Australia PTY LTD

REMEMBER TO RETAIN YOUR ORIGINAL INVOICE FOR PROOF OF PURCHASE.

A series of horizontal dotted lines for taking notes.

UNIMIG

*Razor*Weld

UNIMIG

Welding Guns Of Australia Pty Ltd

ABN: 14 001 804 422

112 Christina Rd, Villawood, NSW 2163

Phone: 1300 864 644

Fax: (02) 9780 4244

Email: sales@unimig.com.au

www.unimig.com.au